

HIGH-PRESSURE ACCESSORIES CATALOGUE

2020 / 2022

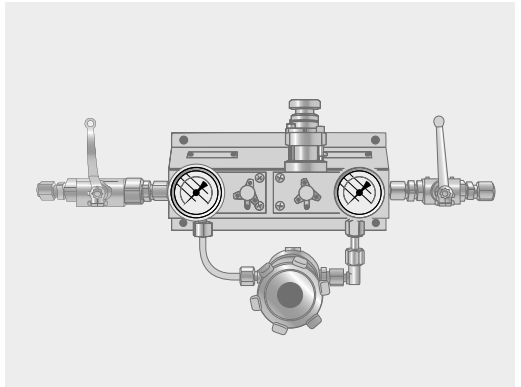
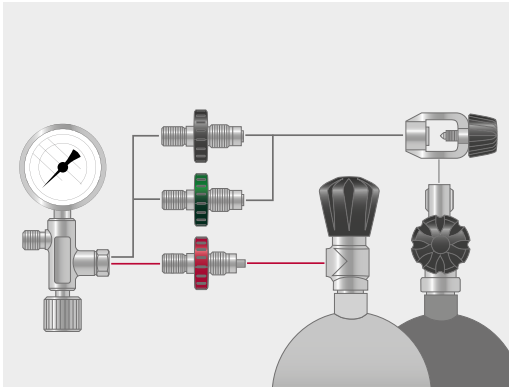
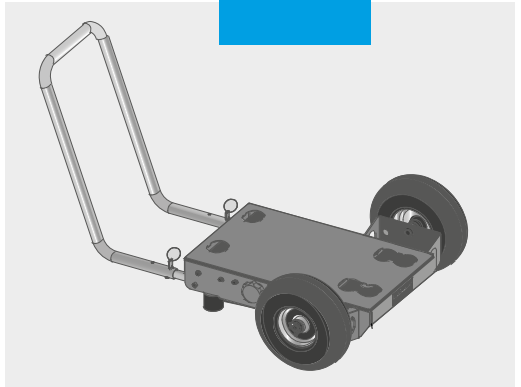

SAFETY

PRECISION

INDEPENDENCE

WORLDWIDE



**QUALITY IS THE FOUNDATION
OF OUR BUSINESS**

FURTHER INFORMATION

concerning our product range and the products shown here can also be found on our website: www.bauer-kompressoren.de

INDEX

A

AERO-GUARD: **18**
 AEROTEST: **21**
 Aluminium clamps: **109**
 Angle screw connector: **124**
 Automatic condensate drain: **30**
 Automatic selector unit: **67, 76, 77**

B

Ball valves: **94**
 BAUER-P-System: **8**
 B-DETECTION: **23**
 B-DRAIN: **31**
 B-KOOL: **20**
 B-TIMER: **16**
 Bulkhead connectors: **121, 122**

C

Circuit breakers: **136**
 CO2 removal: **18**
 Condensate collection vessel: **32**
 Cutting rings: **128**
 Cylinder connectors: **45**

D

Dome pressure reducer: **97, 102**

E

External filling panel: **67**

F

Filling connection: **43**
 Filling hose: **75, 142**
 Filling panels: **62, 66**
 Filling stations: **62, 64, 67**
 Filling valves: **41**
 Filter cartridges: **9, 13**
 Filter systems: **11, 12**

H

Hand-wheel: **66, 75, 99**
 High pressure hoses: **114**
 Hose connection: **65, 66, 67, 68, 75**
 Hoses: **45, 110, 112**

I

Inline arrangement options: **36**
 Intake pre-filter: **6**

J

JUNIOR: **139**
 JUNIOR II: **139**

K

KAP: **32**

L

L-male connectors: **134**
 Lock nuts: **129**
 L-shaped screw fittings: **127**

M

Male connectors: **120, 123, 130, 131, 134, 135**
 MARINER: **30**
 Membrane pressure reducer: **101**

N

NIROSTA: **119**

O

OCEANUS: **140**
 Oil: **8, 13, 153, 154, 158**
 Oil types: **152, 153**
 Operating hours counter: **16, 82, 83**
 Operating hours monitoring: **16**

P

Pipe clamps: **106**
 Pipe fittings: **116, 118, 119**
 Pressure conversion kits: **142**
 Pressure monitoring: **85**
 Pressure reducer: **30, 65, 68, 75, 97, 98, 99, 100, 101**
 Pressure retention valves: **95, 96**
 Pressure transducer: **86, 87**
 Pressure vessel: **38, 76, 95**
 Pressure vessels: **40**
 Protection switch: **136**
 P-system: **8**
 Purification system: **11**

Q

Quick-action coupling: **60**

R

Reduction adapters: **132**

S

Safety valves: **90**
 SECURUS: **9**
 Single module: **38**
 Storage bottles: **36**

T

Thermometer: **84**
 Trolley: **143**
 T-shaped screw fitting: **125, 126**

U

UNIMAM: **50**

V

Valves: **88**
 VERTICUS: **32**

CONTENTS

Intake pre-filter	6	Filling valve accessories.....	52
Inlet adapter.....	7	Distribution connectors	56
Intake filter inserts.....	7	Distribution connectors expansion.....	57
Purification systems.....	8	Check valves.....	58
SECURUS safety system	9	Quick-action couplings.....	60
P80 to P140 purification systems	10	Filling stations.....	62
Purification systems.....	11	Overview of filling panels – for wall mounting...66	
Purification systems.....	12	Type series "External filling panel"	67
Filter cartridges.....	13	Selection criteria.....	68
P-systems filter cartridges	14	External filling panels.....	69
Clamping bracket.....	15	Versions for units with	
P-filter monitoring/B-TIMER	16	B-CONTROL control system	70
CO ₂ removal / AERO-GUARD	18	Versions for units with conventional	71
B-KOOL	20	(hard-wired) control system	71
AEROTEST-SIMULTAN HP	21	Distribution panels compact	74
B-DETECTION PLUS	23	Your product advantages at a glance	75
Gas removal adapter for B-DETECTION PLUS m26		Automatic selector unit.....	76
BAUER B-DETECTION test and calibration gases27		Pressure gauge	78
Technical information on pipe dimensioning.....	29	Pressure gauge selection	79
Automatic condensate drain	30	Screwed fitting for pressure gauge	80
How does the B-DRAIN actually work?.....	31	Operating hours counter	82
Condensate collection vessel.....	32	Thermometer	84
Test protocol for breathing air sample	33	Pressure monitoring.....	85
New accessories for the COMPACT LINE	34	Pressure transducer.....	86
Overview of combination possibilities.....	36	Valves	88
Pressure vessel, single module	38	Safety valves, type-tested	
Storage battery, B80-S.....	39	with TÜV	90
Storage battery, B80-B.....	40	Safety valve adapter.....	92
Filling valves.....	41	Ball valves	94
Filling connectors.....	43	Pressure retention valves.....	95
Cylinder connector with spin valve.....	44	Pressure reducers.....	97
Filling valve throttle insert.....	45	Pressure reducer air, gases.....	99
Safety cylinder connectors.....	45	Piston pressure reducer air.....	100
Filling valves.....	46	Membrane pressure reducer.....	101

Dome pressure reducers.....	102	Circuit breakers / FI protection switch.....	136
High-pressure reducing unit.....	103	Phase sequence monitoring.....	137
Precision stainless steel pipe.....	104	KAA – Retrofitting of JUNIOR II & OCEANUS ...	138
Pipe clamps	106	JUNIOR II conversion kits.....	139
Plastic clamps.....	107	OCEANUS conversion kits.....	140
Aluminium clamps.....	108	Motor spare part numbers for COMPACT LINE	141
Hoses.....	110	Retrofit kits for automatic condensate drain...	141
Hose break protection	111	Operating pressure conversion kits	142
Filling hoses	112	Super Silent retrofit kits.....	142
Filling hoses with UNIMAM connector	113	Trolley	143
High pressure hoses	114	Special tools	144
Cutting ring screwed fitting.....	115	Tool recommendations.....	146
Overview of the most common pipe fittings.....	116	Oil types.....	152
Straight pipe connectors (GS)		Oil	154
Normal version.....	118	Prelubrication oil pump.....	156
Straight pipe connectors (GS)		BAUER KOMPRESSOREN maintenance kits	158
Stainless steel version	119	Clothing	198
Straight male connectors (GES).....	120	Baseball Cap and Bags.....	200
Straight bulkhead connectors (GSV)	121	Giveaways	202
Angle bulkhead connectors (WSV)	122	Office and Organisation	204
Angle male connectors (WEV)	123	Tools and Technology.....	206
Adjustable angle screw connector (eWS).....	124	Cups, Mugs & Co	208
T-connectors (TV).....	125	Flags and Posters.....	210
Adjustable T-connectors (ETS)	126		
Adjustable L-connectors (ELS)	127		
Cutting rings	128		
Lock nuts	129		
Sealing plugs (VS)	129		
Straight male connectors (GEV).....	130		
Straight male connectors (GES).....	131		
Reduction adapters (RED).....	132		
Angle screw connectors (WV)	133		
L-male connectors (LEV)	134		
T-male connectors (TEV)	135		

INTAKE PRE-FILTER

Intake pre-filters are connected to the existing intake filter on the compressor by means of a hose. They are provided for keeping away coarse impurities such as leaves, paper or other foreign bodies as well as for positioning the intake point where the intake air is cleaner.

Particularly important in breathing air-compressors with an internal combustion engine!

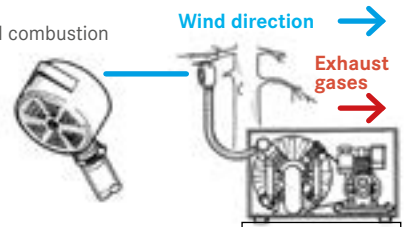

TECHNICAL DATA

- › **Filter fineness of the pre-filter:** approx. 3mm Ø
- › **Air flow rate:** up to 600 l/min

FOR COMPRESSOR TYPES: UTILUS, CAPITANO, MARINER, KAP14, K100, K120, K12.14
UP TO YEAR OF MANUFACTURE 2004

Designation	Order number
Intake pre-filter complete with hose and clamp	014539-KD
Scope of delivery	
Pre-filter	057691
Intake hose 3 m length, internal diameter 25 mm	N1005
Hose clip	N2011

FOR COMPRESSOR TYPES: KAP 15, K150, K180

Designation	Order number
Intake pre-filter complete with hose and clamp	014663
Scope of delivery	
Pre-filter	057692
Intake hose 3 m length, internal diameter 30 mm	N3034
Hose clip	N2011

FOR COMPRESSOR TYPES: UTILUS-II, CAPITANO-II, MARINER-II, K100-II, K120-II, K12.14, KAP15, K150, K180
(FROM 03/2004)

Designation	Order number
Intake pre-filter complete with hose and clamp	82946
Scope of delivery	
Pre-filter	057691
Intake hose 3 m length, internal diameter 40 mm	N27481
Hose clip	N27540
Reduction adapter (only for K150/K180)	82814

INLET ADAPTER

Intake of pure breathing air without contamination from exhaust gases and above all, CO: As an option for JUNIOR, OCEANUS and PE100 compressors, an intake manifold with intake hose will be available with immediate effect for installing the intake equipment at a suitable location for systems with petrol engines in particular.



Designation

Intake manifold complete with intake hose, (3m)

Order number

181618

Scope of delivery

comprising intake manifold with o-ring

183627

Hose with intake filter, hose length 3 m

82946

INTAKE FILTER INSERTS

- › **Function:** Cleaning the intake air
- › **Dimensions:** Diameter: 67 mm to 124 mm, length: 72 mm to 320 mm
- › **Change frequency:** According to local conditions

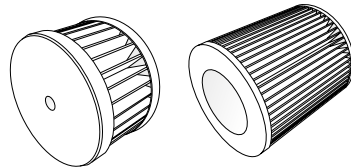

N4823

N25950

Use

Small systems (JUNIOR, OCEANUS, S30)

N4823

IK100 – IK12.14 up to 6.2004

N70

IK100 – IK12.14 from 6.2004 onwards

N25950

IK150 – IK22.0 up to 2001

N3029

K23.0 before 2009

N18906

IK150 – IK18.1 from 2001 onwards
IK150 – IK23 up to 2001

N25886

Large blocks / medium pressure
(K28.3, 21.0, 25.0, 23.1, 25.4, K28.0, K28.2)

N7698

New large blocks from 2008 onwards (K23.0, K24.4)

N29569

PURIFICATION SYSTEMS

BAUER P-SYSTEM: PURIFICATION OF AIR, HE, AR, N₂

The quality of the highly compressed gases does not meet most requirements, because they may be saturated with up to 100% water vapour, contain oil and particles from the compressor unit, as well as being polluted with odours and flavourings. In addition, purification is also important to avoid corrosion, contamination, icing and the growth of microorganisms. BAUER-P systems adsorb residual moisture, oil vapour, traces of gas on the basis of hydrocarbons, depending on the choice of cartridge. Carbon monoxide is burned catalytically into CO₂. For more information, see "Filter cartridges".

BAUER-P systems meet all requirements of DIN EN 12021:2014 for breathing air, or undershoot the limit values by far.¹

The compressed medium is first passed through the mechanically operating oil and water separator. Pre-condensed constituents are separated from the air or gas flow in this case. The 100%-saturated medium containing oil vapours now flows through a check valve into the adsorber. Here, in the first layer, the molecular sieve, water vapour are removed from the medium by adsorption.

The subsequent activated carbon removes the remaining oil constituents from the air/gas flow, as well as the odours and flavourings. Another molecular sieve as well as a particulate filter purifies the medium further before it leaves the filter cartridge. A pressure retention check valve connected to the outlet piping of the purification system ensures there is always a constant minimum pressure in the system, for optimum purification.

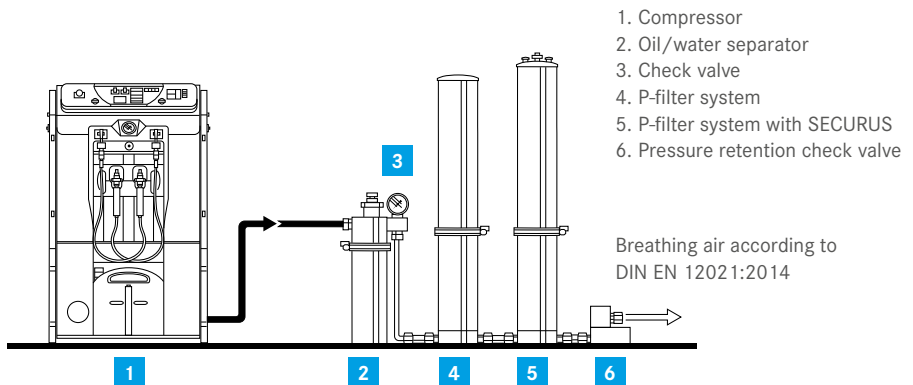

¹ If the units are maintained and installed correctly as described in the user manual and subject to the BAUER AERO-GUARD being used if CO₂ concentration in the intake air exceeds prescribed standard values. Local TLV values are not considered.

SECURUS SAFETY SYSTEM

FOR YOUR SAFETY

All purification systems from P41¹ onwards can optionally be equipped with our SECURUS safety system (for P21 and P31, we recommend the B-TIMER).

The SECURUS system monitors the H₂O saturation of the filter cartridges by measuring the moisture in the molecular sieve and shows this on the display of the BAUER controller as an advance warning in good time; this allows a new cartridge to be inserted at the optimum time.

If the cartridge is saturated and is not changed in good time, SECURUS automatically switches the compressor unit off, and also displays this visually.

SECURUS guarantees optimum dryness of the breathing air according to DIN/EN 12021 and 100% utilisation of the filter cartridge.

The SECURUS system is not suitable for petrol and diesel-operated systems.

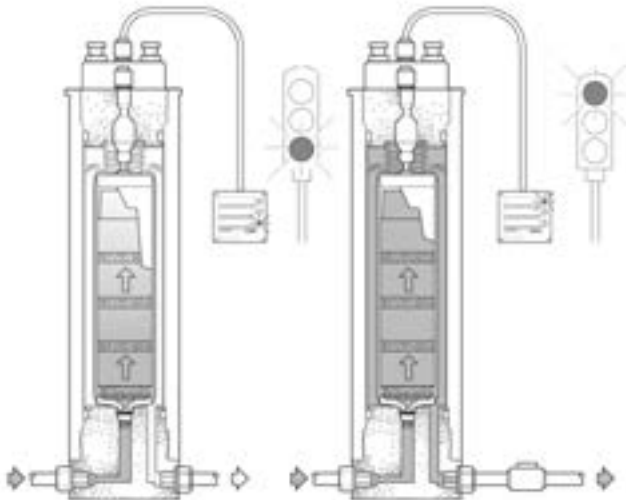

¹ B-TIMER is recommended for purification systems P21 and P31; details can now be found on page 16.

P80 TO P140 PURIFICATION SYSTEMS

FOR SUBSEQUENT UPGRADING OF YOUR COMPRESSOR SYSTEM.

STANDARD SCOPE OF DELIVERY

- › Oil and water separator with cyclone separator and type-tested safety valve as well as manual condensate drain valve. (Automatic condensate drainage at extra cost)
- › System pressure gauge with bleed valve
- › Filter circuit with pressure vessels made of steel or aluminium.
- › Acceptance according to pressure equipment directive.
- › 1 set of filter cartridges
- › Filter key for opening the filter head (cartridge change).
- › Pressure retention check valve with output pressure gauge.
- › All components are mounted on a console and fully piped up.

The size depends on the particular purification system. (P60 – P140)

SECURUS MONITORING UNIT

Optional special accessories: For monitoring the moisture content of the dryer cartridges. Displayed messages and actions: System in **operation** **advance warning** **shut-off**

SCOPE OF DELIVERY

For systems without electrical control system

- › SECURUS filter housing
- › Monitoring device for displaying the operating status of the filter cartridge(s)
- › Connecting cable from the filter housing to the monitoring device

For systems with electrical control system

- › B-CONTROL
- › Filter housing with B-SECURUS signal converter
- › Connecting cable from filter housing to B-CONTROL

The operating condition of the filter cartridge(s) are displayed via the instrument panel of the B-CONTROL

- | | |
|---|--|
| 1. Safety valve | 7. Purifier |
| 2. Pressure input | 8. Filter key |
| 3. Oil/water separator | 9. Pressure maintaining and check valve with output pressure gauge |
| 4. Condensate drain valve | 10. Pressure output |
| 5. System pressure gauge with bleed valve | |
| 6. Drying filter | |

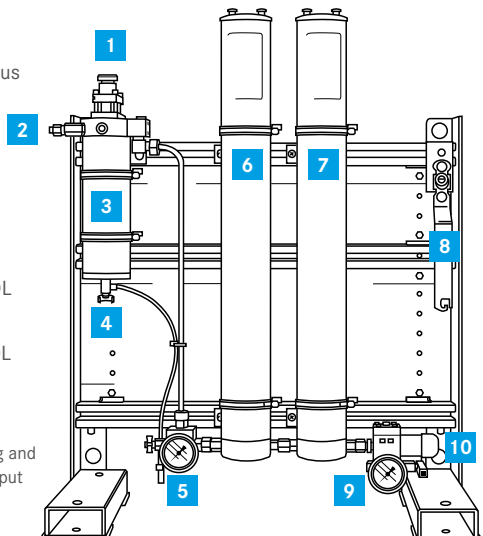

PURIFICATION SYSTEMS

CO CONVERSION

The purity of the air is increased by converting some of the CO into CO₂. This additional catalysis is particularly recommended if you operate your compressor with an internal combustion engine or, due to the location, air contaminated with CO could be drawn in.

The purification systems P21/31/41/P 61 use a special catalyst filter cartridge for this purpose (see also the Replacement cartridges point).

From purification system P 80 onwards, there is an additional filter on the output.

FILTER CARTRIDGES FROM BAUER – THE GENUINE MATERIAL!

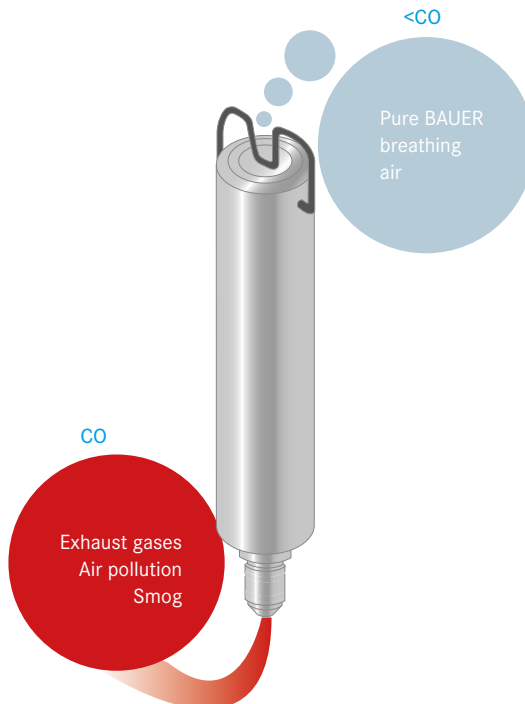

PURIFICATION SYSTEMS

PRESSURE SWITCH / PRESSURE SENSORS

As a separate unit for installation in the output line of the P-system after the pressure retention valve, for switching off the compressor when the final pressure is reached.

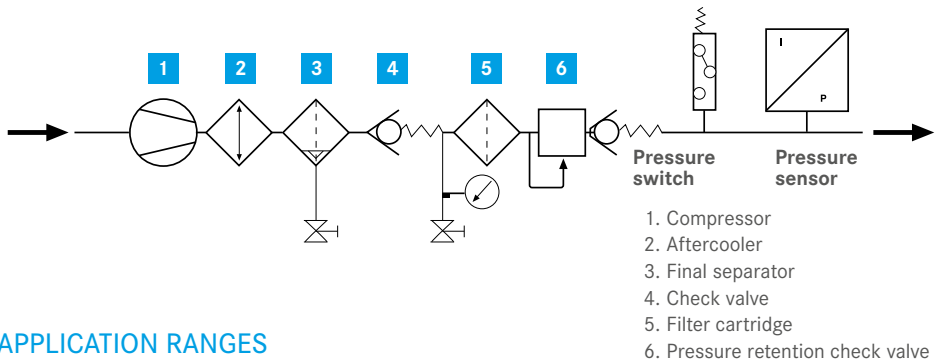

APPLICATION RANGES

- › **Pressure switch:** HardWired controllers
- › **Pressure sensor:** Electronic controls (e.g. B-Control)

P-PURIFICATION SYSTEMS CONSTRUCTION KIT FOR INSTALLATION

Loose components without fastening and piping material.
P-purification systems with special equipment on request.



Please tell us what you need.
We will be happy to advise you.

FILTER CARTRIDGES

All purification systems meet or undershoot the limits of DIN EN 12021:2014.

The gas is purified in the following sequence, depending on the cartridge type used:

- › Coarse removal of oil/ and water droplets: with oil and water separator.
- › Removal of water vapour H₂O: with molecular sieve (MS)
- › Removal of oil vapour and odours C_xH_y: with activated carbon (AC), either standard with breathing air, or optional for industry
- › Conversion of carbon monoxide CO into CO₂ (optional): with hopcalite (HP)
- › Remove of coarse particles: with the filter discs of the filter cartridges

The purification systems and corresponding individual cartridges are presented below. We will be happy to advise you on cartridges for special applications.



AIR QUALITY AS PER DIN/EN 12021:2014:

Contamination with	Maximum content as per DIN EN 12021:2014	Air quality by BAUER
H ₂ O	25 mg/m ³	≤ 10 mg/m ³
CO	5 ppm(v)	Depends on cartridge 1
CO ₂	500 ppm(v)	Depends on intake air ²
Oil	0,5 mg/m ³	≤ 0.1 mg/m ³

1 Only with BAUER special filter cartridge with hopcalite up to a maximum concentration of 25 ppm CO in intake air. The compressed clean breathing air then contains a maximum of 5 ppm CO.

2 Where the intake air exceeds the maximum permissible level of CO₂ as per DIN EN 12021:2014, use of a BAUER AERO-GUARD system is urgently recommended!

P-SYSTEMS FILTER CARTRIDGES

Purification systems	Air purification					
	Breathing air	Breathing air	Breathing air	Breathing air	Industrial air	Industrial air
	H ₂ O/Oil	H ₂ O/Oil/CO	H ₂ O/Oil/CO/SEC	H ₂ O/Oil/SEC	Oil/H ₂ O	Oil/H ₂ O/SEC
P21	1x 057679	1x 059183	—	—	—	—
P31	1x 80100	1x 80114	—	—	—	—
P40	1x 062565	1x 067224	1x 061687	1x 061686	1x 090379	1x 091026
P41	1x 062565	1x 067224	1x 061687	1x 061686	1x 090379	1x 091026
P60	1x 058826	1x 058827	1x 060037	1x 060036	1x 068622	1x 090984
P61	1x 058826	1x 058827	1x 060037	1x 060036	1x 068622	1x 090984
P80	1x 058825 1x 058826	1x 058825 1x 058827	1x 058825 1x 060036 1x 063282	1x 058825 1x 060036	1x 058823 1x 068622	1x 058823 1x 090984
P81	1x 058825 1x 058826	1x 058825 1x 058827	1x 058825 1x 060036 1x 063282	1x 058825 1x 060036	1x 058823 1x 068622	1x 058823 1x 090984
P 100	2x 058825 1x 058826	—	2x 058825 1x 060036 1x 063282	2x 058825 1x 060036	2x 058823 1x 068622	2x 058823 1x 090984
P 101	2x 058825 1x 058826	—	2x 058825 1x 060036 1x 063282	1x 058825 1x 060036	2x 058823 1x 068622	2x 058823 1x 090984
P 120	1x 067099 1x 067867	—	1x 067099 1x 067097 1x 065562	1x 067099 1x 067097	1x 067812 1x 067867	1x 067812 1x 068067
P 140	2x 067099 1x 067867	—	2x 067099 1x 067097 1x 065562	2x 067099 1x 067097	2x 067812 1x 067867	2x 067812 1x 067097

H₂O (drying)

Oil (oil removal)

CO (carbon monoxide conversion)

SEC (SECURUS connection)

CLAMPING BRACKET

CLAMPING BRACKET FOR ATTACHING SEPARATOR AND FILTER HOUSINGS:

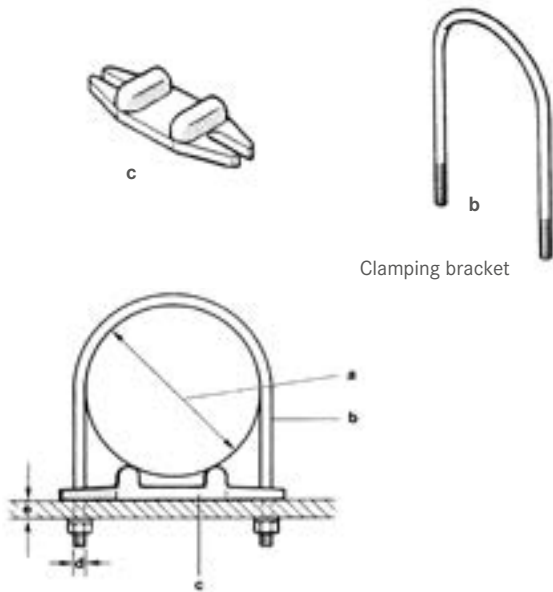

Clamping bracket

Self-locking M8 nut
U-washer
2 of each are required.

Order no. N 370
Order no. N 58

Internal diameter	Thread diameter	Wall thickness	Clamping bracket	filter support for this
mm	mm	mm	Order number	Order number
(a)	(d)	(e)	(b)	(c)
76	M8	1 - 8	14584	12917-M
80	M8	1 - 8	14946	12917-M
97	M8	1 - 20	61544	63599-M
110	M8	1 - 5	68817	63599-M
117	M8	1 - 5	65831	63599-M

P-FILTER MONITORING /B-TIMER

The filter cartridge change with the B-TIMER is safe, easy and economical.

The minicomputer counts the operating hours and reliably shows the cartridge service life. Clear signals are output when cartridges need to be changed or maintenance is due.

The B-TIMER can be fitted or retrofitted to all mobile BAUER KOMPRESSOREN. (Except P11)
Easiest possible installation – a screwdriver is all it takes.

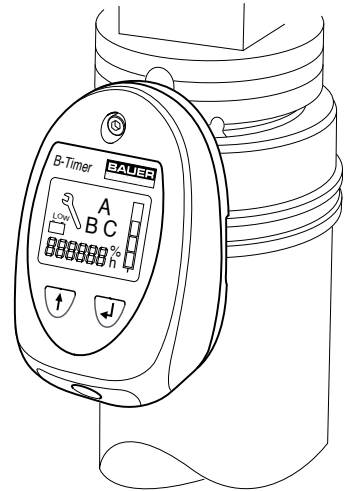

TECHNICAL DATA

- › Monitoring: P21, P31 and P41 purification systems for 200 bar and 300 bar in COMPACT LINE, PROFI LINE (II) and PE-HE and -TE -TE models
- › Battery service life: approx. 3 years at 500 hours/year
- › Operating hours counter: integrated
- › Display: Maintenance, maintenance kit, cartridge saturation level, cartridge number, starts and stops automatically
- › Properties: protection against dust and water spray, insensitive to strong sunshine, high air humidity and sand

Designation	Order number
B-TIMER	N27286
Replacement battery	82743
Hose clamp P21 / P31 (80-100 mm)	166310
Hose clamp P41 (90-110 mm)	N15499

CO₂ REMOVAL / AERO-GUARD

FOR REDUCING THE CO₂ CONTENT IN COMPRESSED BREATHING AIR.

CO₂ pollution is increasing steadily in our environment. BAUER KOMPRESSOREN offers an efficient way to clean CO₂ out of the breathing air.

An ingenious bypass system passes the drawn-in air through the AERO-GUARD. Only about 2/3 of the air flows through the filter cartridge, which adsorbs the CO₂. In this way, the CO₂ content is reduced to 1/3 of the value in the drawn-in air – far below the strict limits of DIN 12021. At the same time, the AERO-GUARD leads to longer filter life time.



TECHNICAL DATA

- › **For delivery rates:** from 100-700 l/min in AERO-GUARD-DUO up to 1000 l/min
- › **Input concentration:** max. 1000 ppm-vol. CO₂
- › **Output concentration:** max. 330 ppm-vol. CO₂ = approx. 1/3 of the input concentration
- › **Service life:** min. 50 hrs. at (600 l/min and 1000 ppm-vol.), correspondingly longer with lower delivery rate
- › **Rel. humidity:** 0 - 100% of the drawn-in air
- › **Temperature range:** +5 °C - +45 °C
- › **Dimensions:** WxDxH 50x46x72
- › **Operating weight:** 26 kg

Filter can be changed without tools.

SCOPE OF DELIVERY INCLUDES

AERO-GUARD S-XXL:

1x filter cartridge (9 kg special carbon dioxide absorbent)
10x Micropur sterilisation tablets

AERO-GUARD-DUO1000:

2x filter cartridge (9 kg special carbon dioxide absorbent)
20x Micropur sterilisation tablets

Please order appropriate connecting hoses separately.
(see accessories)

Designation/Size	suitable for free air deliveries	Dimensions (W x D x H)	Operating weight incl. filter and water
	l / min. ¹	cm	kg
AERO-GUARD-S	100 – 150	50 x 46 x 72	approx. 26
AERO-GUARD-M	160 – 230	50 x 46 x 72	approx. 26
AERO-GUARD-L	220 – 320	50 x 46 x 72	approx. 26
AERO-GUARD-XL	330 – 450	50 x 46 x 72	approx. 26
AERO-GUARD-XXL	460 – 700	50 x 46 x 72	approx. 26
AERO-GUARD-OX-L	260 – 320	50 x 46 x 72	approx. 26
AERO-GUARD-OX-XL	330 – 450	50 x 46 x 72	approx. 26
AERO-GUARD DUO-1000	650 – 1000	85 x 63 x 87	approx. 55

Accessories	Hose internal diameter LP / LP	Area of application	Order number
Intake hoses, input side			
Intake hose cpl.	60/60		79377
Intake piece with sleeve ²	100 / 60		79423
Intake hose to intake piece 79423 ¹⁾			N25150
Intake hoses, output side			
Intake hose cpl.	60 / 40	open systems	83336
Intake hose cpl.	60/60	IK100II - IK120II,	79377
Intake hose cpl.	60 / 40	IK12.14II	83337
Intake hose cpl.	60/60	open systems	79378
Intake hoses, output side, for older compressor models			
Intake hose cpl.	60 / 32	open systems K100 - K120 (with intake filter 013758); produced before July 2004, K15 (with intake filter 056372)	79376
Intake hose cpl.	60 / 25	K100 - K120 (with intake filter 013758); produced before July 2004	79422
Replacement filter cartridge			
Filter cartridge incl. 10x water disinfection tablets for every 10 litres of water			79050
Water disinfecting tablet without filter cartridge, 40 pcs			N25882-40

1 Delivery quantity of the connected compressor measured with cylinder filling from 0 – 200 bar ±5%.

2 Order hose ND 100 separately; length as required, however not more than 20m; order no. N25150

B-KOOL

A long filter life time or capacity is decisive for cost-effective operation of professional filling stations. The temperature of the compressed medium has a significant influence on this.

Our B-KOOL significantly extends the life time of filter cartridges many times over, it is equipped with an integrated separator as well as automatic condensate drain and removes a large proportion of the humidity before it can get into the filter system.

TECHNICAL DATA

- › **Medium:** Air
- › **Operating temperature:** + 5 - + 45 °C
- › **Input temperature:** max. + 60 °C
- › **Maximum operating pressure:** 350/500 bar
- › **Minimum operating pressure:** 100 bar
- › **F.A.D. range:** 200 - 700 l/min
- › **Power consumption:** max. 550 W at 50 Hz

Options	PROFI-LINE	MV III	KAP	PE TE/HE	PE VE/ OPEN	VERTICUS 5	PE VE/SILENT
Model			B-KOOL 680s			B-KOOL 680i ¹⁾ /B-KOOL 680s	
P41 filter system	●	●	●			●	
P61 filter system		●	●		●	●	●

● ex-works or can be retrofitted | ○ Only ex-works, no retrofitting possible

Operating pressure PN-max	Voltage range	Frequency
B-KOOL 680i Use V5,PE,VE Weight 50 kg Dimensions 75x35x53 cm (WxHxD)		
350 bar	200-240 VAC	50/60 Hz
500 bar	200-240 VAC	50/60 Hz
B-KOOL 680s Use PROFILINE, PE HE, PE Ve, MV, V5 Weight 48 kg Dimensions 38.5x70,53.5 cm (WxHxD)		
350 bar	200-240 VAC	50/60 Hz
500 bar	200-240 VAC	50/60 Hz

1) integrated into the system on site 2) only with PE 250 HE and PE 300 TE/HE

INSTALLATION MATERIAL	B-KOOL 680i (integrated)		B-KOOL 680s (stand-alone)
for compressor units:	Filter system	Pressure range	Order no.
VERTICUS / PE-VE	P 41 / P 61	350 bar	129016
VERTICUS PE-VE	P 41 / P 61	420 bar	129056
MINI-VERTICUS III	P 41 / P 61	350 bar	160028
MARINER 200/250/320	P 41	350 bar	129021
VERTICUS	P 61	500 bar	172323

AEROTEST-SIMULTAN HP

Increasing damage to the environment and enforced regulations for breathing air quality such as DIN EN 12021:2014 mean that the requirements to be met by the operators of filling stations are getting stricter all the time. With the portable AEROTEST SIMULTAN HP, you will always be on the safe side.

The test tubes used make it possible to check compliance with the limit values for CO, CO₂, water vapour and oil vapour simultaneously (using the new "Impactor"), and reliably in the compressed air. The device is designed so that incorrect measurement results due to mishandling are practically ruled out. Preliminary calibration is no longer required. The pressure reducer and the special nozzles in the test tube adaptor provide a constant flow and consistent measuring accuracy.

TECHNICAL DATA

- › **Input pressure:** 10 to 300 bar
- › **Test time:** 5 min
- › **Flow rate:** 0.2 and 0.4 l/min
- › **Connection:** G 5/8"
- › **Weight:** approx. 3kg
- › **Case dimensions:** 35x30x8cm (WxDxH)



PRODUCT INFORMATION

The AEROTEST-SIMULTAN HP is suitable for a pressure range from 10 to 300 bar. The AEROTEST-ALPHA LP is designed for the pressure range up to max. 15 bar. An Impactor adapter with an inserted impactor is used for measuring the remaining oil content.

Article	Order number
AEROTEST-SIMULTAN HP (complete in test case with all accessories)	N31565
AEROTEST-ALPHA LP (complete in test case with all accessories)	N25537
Replacement article	
Test tubes for CO (box with 10 tubes)	N15523
Test tubes for CO ₂ (box with 10 tubes)	N15522
Test tubes for H ₂ O (box with 10 tubes)	N25535
Impactors for oil (box with 10 impactors)	N31173
Test tubes for oil (box with 10 tubes)	N15521
Replacement rubber holder for test tube, 1 piece	N25812
Impactor adapter	N31184
Test tube opener	N25813
Pressure reducer with G 5/8" hand connector	N25815

B-DETECTION PLUS

The B-DETECTION PLUS is the ideal permanently installed measurement system for online monitoring of CO₂, CO, O₂, absolute humidity and VOCs (residual oil) in compressed breathing air. If the preset limit values are exceeded, an error message appears on the display and the system switches off the compressor. The system is available in two variants: Integrated as B-DETECTION PLUS i in a MINI-VERTICUS or VERTICUS or as stand-alone variant B-DETECTION PLUS s for all other BAUER KOMPRESSOREN with control system as well as for retrofitting to existing systems. Via the B-CONTROL MICRO control, exceeding of the limit values can be stored in the log book and simply transferred onto a computer via SD card and read out in Excel.



- › Alarm and fault messages are triggered when predefined limit values¹ as per DIN EN 12021:2014¹ are exceeded
- › Direct connection to the system control (B-CONTROL MICRO or B-CONTROL II) possible
- › Available as variant integrated into the compressor or as stand-alone variant

TECHNICAL DATA ON SENSOR MODULE

B-DETECTION PLUS	integrated	stand-alone
› Medium	Air; Nitrox ² (max. 40% O ₂)	
› Permitted operating pressure (AIRBOX input)	max. 350bar (higher pressures on request)	
› Permitted free air delivery (AIRBOX input)	max. 850l/min (higher free air delivery on request)	
› Permitted operating temperature:	+5°C ... +45°C	
› Permitted storage temperature	-10°C ... +50°C	
› Max. permitted impact loading	2 g	
› Operating pressure (sensors)	Ambient pressure (approx. 1013mbar)	
› Maximum permitted ambient humidity	0 ... 90% non-condensing	
› Permitted operating environment	non-explosive	
› Operating voltage/frequency	24 V DC	100 - 250 VAC, 50/60 Hz
› Power consumption	Connection via compressor	max. 50 W
› Flow volume (compressed air flow)	1.0 to 3.0 l/min	
› Outputs	-	3 relay outputs
› Serial connection	Modbus RS485 (used internally)	CAN-Bus, Profibus DB optional with gateway, Ethernet interface
› Gas input connection	6 mm	
› Weight	3 kg	8.5 kg
› Dimensions (H x W x D) with connectors	160 x 260 x 92 mm	462 x 354 x 184 mm

¹ Measurement of humidity and VOC (residual oil) optional ² VOC limit value monitoring for Nitrox not possible at present

B-DETECTION PLUS m

THE MOBILE SOLUTION FOR RELIABLE BREATHING AIR MEASUREMENT

As a compact, mobile case solution, B-DETECTION PLUS m gives you the freedom to perform reliable breathing air measurements, whenever and wherever you want.

As with the stationary variants, observation of the limit values in DIN EN 12021 for CO, CO₂, O₂ as well as optionally for absolute humidity and residual oil (VOC)¹ can be verified reliably and with high precision.

B-DETECTION PLUS m offers a wide range of measurement options: The standard gas removal unit can be used to measure the air quality in the breathing air cylinder. As an option, the measurement can also be carried out directly on the compressor. It is also possible to measure the intake air before introduction into the compressor.

The control system permits the selection of tailor-made measurement profile for the corresponding measurement on the compressor or cylinder.

For challenging ambient conditions, the transport case is designed to be dust and spraywater resistant in accordance with the IP 65 Standard. The optimum ease of maintenance, the access to the sensors is unfastened especially quickly and easily.

Legal security in the measurement process is provided by an integrated data logger with SD card function that permits defined individual measurements.

Thanks to the patented special construction, it has been possible to shorten the response time of the dewpoint sensor so much that the humidity measurement is virtually free of delay.

The rapid ventilation permits rapid disconnection of the gas removal unit from the coupling point for air extraction.

If a limit value is exceeded, the control system sounds an alarm via an optical warning message.



¹ Measurement of absolute humidity and residual oil (VOC) optional. Residual oil measurement only on the basis of the volatile hydrocarbons (VOCs). Sensor calibration based on isobutene.



Gas removal unit with optional dew point sensor



Display with limit value display conforming to DIN EN 12021:2014

ACCESSORY OPTIONS

- ▶ **Battery operation:** The integrated battery facilitates measurements without external power supply. Its capacity permits a measurement duration of at least 5 hours. For especially large numbers of charging cycles, a long-lasting lithium-ferum-polymer type has been selected.
- ▶ **Filling hose adapter:** permits the direct measurement of air coming out of the compressor via connection to the filling hose on the system.
- ▶ **Ambient air pump:** An additional pump installed within the measuring instrument makes it possible to check the gas composition of the intake air. For an overall CO₂ content of 450 ppm or more in the intake air, we recommend using an AERO-GUARD CO₂ absorber.
- ▶ **B-APP:** With the newly developed free B-APP, all current gas measurement data is sent to your smartphone. This means you can see at all times the air quality being used to fill your breathing air cylinders.¹

The B-APP is available free of charge for IOS via the App Store and for Android via Google Play



¹ The prerequisite is that control system B-CONTROL MICRO (+Net) with valid IP address is installed on the same local network (LAN/WLAN) as the smartphone.

GAS REMOVAL ADAPTER FOR B-DETECTION PLUS M

Use	Order number
Adapter for filling valve 300/200 bar	181934
Adapter for filling valve 500bar	183162
Adapter for filling valve 300/200 bar/Nitrox	183163
Adapter for cylinder valve 200bar/Nitrox	N43919
Adapter for cylinder valve 300bar/Nitrox	N43920
T-piece adapter 3 x G5/8 300bar	N44186
T-piece adapter 3 x G5/8 200bar	N44188
Silencer, e.g. for draining cylinder pressure	N44211

BAUER B-DETECTION TEST AND CALIBRATION GASES

In the event of damage, operating firms of a filling plant must provide evidence of only have used clean air for filling. The BAUER B-DETECTION gas measurement systems perform continuous and reliable measurements of all gases in breathing air standard DIN EN 12021:2014.

Users therefore enjoy the maximum degree of safety: Only uncontaminated air is used for filling the breathing air cylinders, meaning divers and firefighters only breathe pure air according to DIN EN 12021:2014.

Special BAUER gas mixtures for the most precise measurement results

With BAUER gas mixtures precisely matched to the sensor technology, you create the basis for precise measurement results. The sensors in the B-DETECTION PLUS systems must be calibrated annually and tested at least every three months.

In order to ensure optimum measurement reliability of the gas detection system and a long equipment service life, we recommend the following inspection intervals:

Types of check	Intervals
Sensor test	Before each use
Visual inspection and leak testing	Monthly
Functional test (incl. sensor test, calibration as necessary)	Every 3 months
System check	Every 12 months
Recording check	Every 36 months

FOR WHOM IS THE B-DETECTION CALIBRATION GAS CASE?

- ▶ The test and calibration gas case contains the basic equipment with all test and calibration gases for your B-DETECTION PLUS gas measurement system. It is intended both for the operator on site who want to regularly test and calibrate the system, as well as for engineers or appropriately trained persons who replace sensors.
- ▶ The test gas case contains the basic equipment with test gases for your B-DETECTION PLUS gas measuring system. It is intended for the operator on site who wants to regularly test the system.

CAN THE GAS CYLINDERS BE SOLD ON INDIVIDUALLY AFTER USE?

- ▶ Naturally this is possible. The order numbers have been listed for you in this information flyer

HOW CAN THE GAS CYLINDERS BE SENT?

- ▶ All gas cylinders with excess pressure can be sent via ship or HGV transportation. Dispatch via aircraft may not be possible depending on the country group based on the hazard class or may only be associated with considerable additional costs.
- ▶ Please check the valid shipping modalities for you before ordering (hazardous goods number of the 1 litre pack: UN2037, 2 litre pack: UN1956).

TEST AND CALIBRATION GAS CASE, COMPLETE: 180907-KD¹

Contents in detail	Number of	Comment	Order number
Case	1x	For test and calibration gases with insert	N42895
Pressure reducer	1x	For test and calibration gas cylinders 1 litre / 12 bar	N42334
Calibration gas	1x	12 litres / calibration gas low for CO, CO ₂ , VOC	N42328
Calibration gas	1x	12 litres / calibration gas high for CO, CO ₂ , O ₂	N42330
Test gas	1x	12 litres / test gas for CO, CO ₂ , O ₂ and high gas for VOC	N42332
Calibration gas	1x	12 litres / calibration gas low for O ₂	N40706

TEST GAS CASE, COMPLETE, SMALL: 181590-KD¹

Contents in detail	Number of	Comment	Order number
Test gas case, small	1x	For test gases with insert	N40381
Test gas	2x	12 litres / test gas for CO, CO ₂ , O ₂ and high gas for VOC	N42332
Pressure reducer	1x	For test and calibration gas cylinders 1 litre / 12 bar	N42334

TEST GAS CASE, COMPLETE, LARGE: 181336-KD¹

Contents in detail	Number of	Comment	Order number
Case	1x	For test and calibration gases with insert	N42895
Test gas	4x	12 litres / test gas for CO, CO ₂ , O ₂ and high gas for VOC	N42332
Pressure reducer	1x	For test and calibration gas cylinders 1 litre / 12 bar	N42334

TOOLS/EQUIPMENT

Tools/equipment	Order number
Pressure reducer + PUR hose 300 litre connection	185665
High calibration gas CO, CO ₂ and O ₂ : Contents 300 litres / 150bar @ 2 litre cylinder	N43678
Low calibration gas (zero gas) CO, CO ₂ and VOC: Contents 300 litres / 150bar @ 2 litre cylinder	N43677
Low calibration gas (zero gas) O ₂ : Contents 300 litres / 150bar @ 2 litre cylinder	N43680
Test gas CO, CO ₂ , O ₂ or high calibration gas VOC: Contents 300 litres / 150bar @ 2 litre cylinder	N43679

¹ Can also be ordered as spare part without case

Hazardous goods number of the 1 litre pack: UN2037
of the 2 litre pack: UN1956

TECHNICAL INFORMATION ON PIPE DIMENSIONING

RECOMMENDATION FOR THE DIMENSIONING OF INTAKE PIPES

Detail	Description
Principles	<p>The maximum length should not exceed 15 (fifteen) metres.</p> <ul style="list-style-type: none"> • Intake pipes should be of a straight design (as far as possible without 45°/90° bracket). • If the pipeline has a straight design, the following standard diameters apply: <ul style="list-style-type: none"> • Up to 10 metres Ø 80mm • Up to 15 metres Ø 100mm
A bracket	<p>If it cannot be avoided to use a bracket, the pipe should be expanded to at least the next larger diameter, e.g.:</p> <ul style="list-style-type: none"> • Up to 10 metres including a (1) bracket Ø 100mm • Up to 15 metres including a (1) bracket Ø 120mm
Each additional bracket	The same applies to any additional brackets that are fitted in the intake line.
General	<p>The inlet side of the suction pipe (external) should be fitted with inlet protection against rain, coarse contamination, insects or birds, for example. The outlet side (in the building) should be implemented as tightly as possible in the direction of the compressor as well as equipped with a vacuum-proof but flexible hose (decoupling of vibrations) and an adapter (Ø inlet pipe = Ø of the flexible hose) on the compressor inlet filter.</p>
Note	The working noise of the compressor is audible – as with any piston compressor – in the external area or at the start of the inlet pipe. Please note this in your plans.

AUTOMATIC CONDENSATE DRAIN

Whether for air, He, Ar, N₂ - regular condensate drainage is required for your compressor too.

COMPRISING

- › Condensate drain valve group with solenoid valve and coil
- › Timer installed in protective housing or compressor controller
- › Pressure reducer for control air supply
- › Cycle counter to measure the condensate drain cycles

If required, contact us specifying your compressor model and operating conditions. We will prepare a corresponding offer for you immediately.

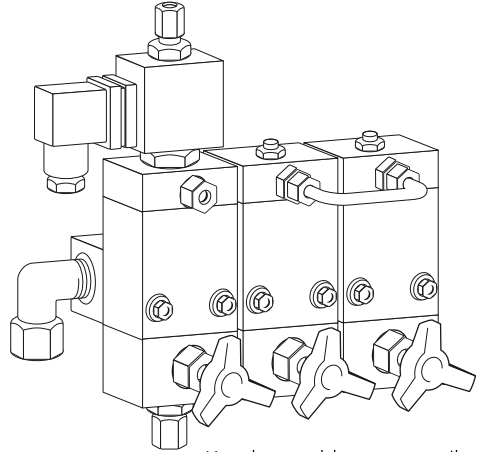

Kondensatablassautomatik

Maintenance kits for (KAA) solenoid valve N27099

Order number

Delivery scope of large maintenance kit

Diaphragms, springs, o-rings, sleeve

N42983

Delivery scope of small maintenance kit

Diaphragms, springs, o-rings

N29429

In crash frame

Filter system P2 1

Filter system P3 1

Filter system P4 1

CAPITANO 140 E

122400

122638

MARINER 320 E

122500

122500

MARINER 200 E

122682

122683

122683

MARINER 250 E

122681

122675

122673

MARINER 320 B¹

123054

123054

¹ Systems with a petrol engine can only be retrofitted if there is an existing electric generator.

HOW DOES THE B-DRAIN ACTUALLY WORK?

B-DRAIN is the successor to the previous classic automatic condensate drain. Thanks to its smart design, it offers a smoother and quieter condensate drain in comparison. The main feature of the new design is that the pressure loss during condensate drainage is reduced. This offers several significant advantages:

Pressure-loaded parts such as the filter vessel and intermediate separator are subject to lower cyclical loads, which increases service life. As the intermediate piping is no longer required for standard applications and the condensate drain valve is fitted directly to the intermediate or oil-water separator, and there is also no need for a flash tank, a much more compact design is possible. Another positive side effect: The reduction of the pressure loss leads to a corresponding gain in delivery volume and energy savings, depending on the unit model in continuous operation.

The heart of the new B-DRAIN is the condensate drain valve, which acts as a pressure reducer: The operating pressure in the condensate separator is reduced from up to 550 bar to 2 to 9 bar pilot pressure.

When the compressor starts (system unpressurised), the condensate valve is open. The solenoid valve (1) is closed. As the compressor pressure builds up, the pilot pressure below the piston (2) also builds up. As a result, the piston is pushed upwards due to the surface ratio, thus closing the condensate drain valve.

The solenoid valve is opened to drain the condensate. This causes the pilot pressure to collapse and the piston is pushed down by the operating pressure on the surface (3) and by the force of the spring (4). The condensate now flows over the piston and through the solenoid valve out of the condensate drain valve. The solenoid valve contains a throttle (5), which causes the pilot pressure to rise again. This pilot pressure closes the piston until a balance of forces is achieved. The discharge pressure



of the condensate or compressed air is thus largely decoupled from the operating pressure. This is the essential difference to the predecessor automatic condensate drainers, in which the condensate or compressed air flows off at the respective stage pressure (16 to 550 bar) into a condensate separator (Winnerltopf, Wilkerson separator). The condensate now flows off directly into the condensate canister at an outflow control pressure of approx. 2 to 5 bar, almost independently of the operating pressure. At the end of the condensate discharge process (time-controlled), the solenoid valve is closed again. This causes the pilot pressure to rise until the condensate valve is closed.

CONDENSATE COLLECTION VESSEL

The condensate collection system provides a central means of collecting the condensate produced during the compression process and separates condensate and air. The condensate collecting tank is equipped with a mechanical level display for visual advance warning when emptying is due, with corresponding control. In addition when the tank is full, a maximum contact can switch off the compressor automatically or trigger an alarm system at the client.

The separated air is channelled through an activated carbon bed so that only clean and odourless exhaust air flows out according to TRG regulations.

The condensate tank is connected to the condensate drain connector of the system by means of a hose.

RETROFIT KIT

For subsequent installation on your KAP or VERTICUS system.

Version/ compressor series	Tank content	Condensate capacity	Activated carbon content	Pipe fitting on hose	Inlet fitting	Connection hose	Dimensions (W x D x H)	Order number
	Litre	Litre	Gramme	Ø mm		Ø mm	mm	
VERTICUS KAP up to K180	approx. 60	approx. 40	3700 g	15	G ½	1150	410 x 330 x 1000	072787
K22 to K28	approx. 60	approx. 40	3700 g	28	G1	1500	410 x 330 x 1000	072788

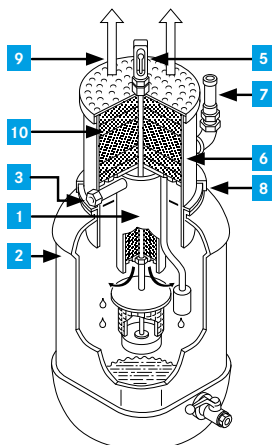

- 1 Condensate separator
- 2 Plastic collection vessel, 60 l
- 3 Condensate inlet G¾ or G1
- 4 Condensate drain valve G½
- 5 Mechanical level indicator
- 6 Filter housing
- 7 Safety valve
- 8 Clamping ring
- 9 Cleaned and odourless exhaust air
- 10 Activated carbon fill

Designation

Maintenance kit for condensate collection vessel

Order number

077935-b1

TEST PROTOCOL FOR BREATHING AIR SAMPLE

Customer
 Inspector
 B-DETECTION PLUS m
 BAUER AEROTEST
 Analysis from pressure vessel*
 Analysis of a compressor**
 Serial number
 Type

Test Medium	Target	Actual	Result
Water	≤ 25mg/m ³ ** ≤ 35mg/m ³ *	_____mg/m ³	OK / Failed
Carbon monoxide	≤ 5ml/m ³ (ppm)	_____ml/m ³ (ppm)	OK / Failed
Carbon dioxide	≤ 500ml/m ³ (ppm)	_____ml/m ³ (ppm)	OK / Failed
Oil / VOC content	≤ 0.5mg/m ³ (breathing air) ≤ 0.1mg/m ³ (nitrox)	_____mg/m ³	OK / Failed
Oxygen	21%+/-1% (breathing air specified value +/-1% (nitrox)	_____%	OK / Failed
Additional			OK / Failed

Comments
 Date
 Executor
 Customer

The test has been performed as part of DIN 12021:2014.

NEW ACCESSORIES FOR THE COMPACT LINE

CONDENSATE VESSEL

With immediate effect, for our JUNIOR and OCEANUS models with automatic condensate drain a condensate collection vessel is also available for the environmentally friendly disposal of the mixture.



Designation	Order number
Retrofitting kit for JUNIOR II and OCEANUS with manual drain	181834
Retrofitting kit for JUNIOR II and OCEANUS with automatic condensate drain	181833
Scope of delivery	
Both retrofitting kits include containers	N30767
Distributor	179279
Holder	N33226
Hose	N42013

ATTENTION!

Extra caution and very precise handling shall be exercised when applying the condensate collecting system during manual condensate drainage.

Sudden and/or uncontrolled pressure release from the intermediate- and/or final separator/filter housing whilst opening the condensate drain valves by hand may cause the plastic canister to burst, which may physically harm the operator and/or any bystander and/or may damage the direct surrounding.

BAUER Kompressoren GmbH shall and will neither accept any liability nor be held liable for any consequence resulting from either neglectful and /or inattentive and/or wrong application of the condensate collecting system for manual drainage.

OVERVIEW OF COMBINATION POSSIBILITIES

STORAGE BATTERY 330 BAR

Accumulator system	Printers	Order number
B 80S with console	330 bar	B 80
B 80 B without console	330 bar	B 80
Accessories		
Connecting line for B 80 S with console		076387
Connecting line for B 80 S without console		076363
Safety valve		059410
Wall attachment		076355
B 160 S standard module		B 160
B 160 A add-on module		B 160

STORAGE BATTERY 360 BAR (SYSTEM OPERATION UP TO 350 BAR)

Accumulator system	Volume	Weight	Order number
	Litre	kg / approx.:	
B 50 S	50	120	B 50
B 50 A	50	120	B 50
B 100 S	100	225	B 100
B 100 A	100	225	B 100

STORAGE BATTERY 420 BAR (SYSTEM OPERATION UP TO 410 BAR)

Accumulator system	Printers	Order number
B 50 S standard module	420 bar	B 50
B 50 A add-on module	420 bar	B 50
B 100 S standard module	420 bar	B 100
B 100 A add-on module	420 bar	B 100

STORAGE BATTERY CNG 330 BAR

Accumulator system	Number of cylinders	geometr. Total volume	Pmax.	Design		
				1-rack	2-rack	3-rack
B800	10	800	330	●	●	●
B960	12	960	330	●	●	●
B1920	24	1920	330	●	●	●
B2000	25	2000	330	●	●	●
B2400	30	2400	330	●	●	●

B 80 S – with console

Upright pressure vessel mounted on console; connection at bottom, with condensate drain valve and air outlet valve; for mounting several storage bottles, connecting line 076387 is required for each additional storage bottle.

Option: installed safety valve (max. 330 bar setting value), at bottom of console.

B 80 B – without console

Storage bottle, with cylinder valve; without condensate drain valve.

Option: clamp for wall mounting.

Connecting cable 076363 is required for each additional storage bottle when adding multiple storage bottles.

B 160 S – standard module

Upright storage bottle, mounted on console; connection at bottom, with condensate drain valve, air outlet valve and safety valve.

B 160 A – add-on module

To expand the standard modules above in any size for increased volume.

Scope of delivery according to standard module, but without safety valve; a connecting line is required for this.

B 50 S / B 100 S – standard module

Upright storage bottle(s), mounted on console; connection at top, with pressure gauge, shut-off valve, bleed valve and safety valve.

-B 50 A / B 100 A – add-on module

To expand the standard modules above in any size for increased volume.

Scope of delivery as per standard module but without pressure gauge and safety valve.

PRESSURE VESSEL, SINGLE MODULE

TECHNICAL DATA

- › **Volume:** 50 litres
- › **Medium:** compressed air, nitrogen, noble gases and natural gas
- › **Operating temperature:** -20 °C to +50 °C
- › **Surface:** rough interior, external RAL 7024
- › **Number of load cycles according to AD-S1:** at 70 to 250 bar = 74,300 cycles¹
- › **Material:** 34 Cr Mo 4, wall thickness: min. 9.4mm
- › Cylinder without cylinder valve

- › **Volume:** 80 litre
- › **Medium:** compressed air, nitrogen, noble gases and natural gas
- › **Operating temperature:** -20 °C to +50 °C
- › **Surface:** rough interior, external RAL 9010 pure white
- › **Number of load cycles according to AD-S1:** at 70 to 250 bar = 74,300 cycles*
- › **Material:** 34 Cr Mo 4, wall thickness: min. 9.4mm
- › Cylinder with cylinder valve

ACCESSORIES

- › Cylinder connection piece 171708
- › Gas cylinder valve N33275

Attention! The tanks are delivered filled with nitrogen!

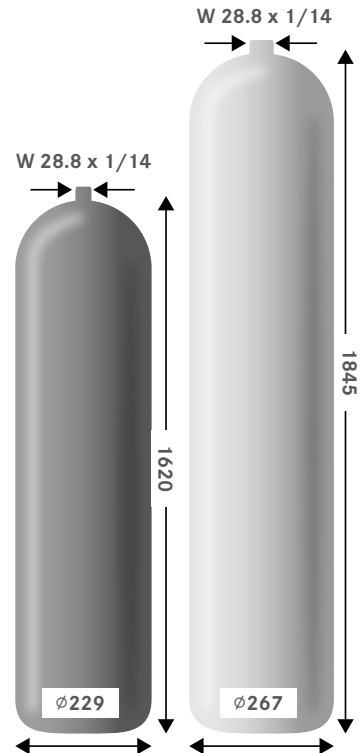

Rated pressure	Volume	Weight	Storage capacity	Test pressure	Connection	Order number
bar	Litre	kg	Litre/bar	bar	acc. to DIN 477	
420	50	approx. 97	20,000/400	630	W28.8x1/14	N33835
330	80	approx. 129	24,000 / 300	472	W28.8x1/14	125012

¹ Calculation according to AD codes of practice with TÜV acceptance according to Pressure Equipment Directive.

STORAGE BATTERY, B80-S

The modules are intended for operation without safety valve and without pressure gauge. The storage battery is supplied with a console and condensate drain, and must be protected via the system.

THE PRESSURE VESSELS MEET THE REQUIREMENTS OF GERMAN REGULATIONS GOVERNING STATIONARY INSTALLATION.

TECHNICAL DATA

- ▶ **Volume:** 80-litre upright with console and connection at bottom, condensate drain and outlet valve
- ▶ **Pressure:** 330 bar
- ▶ **Pipe connection:** for lines with \varnothing 8 mm

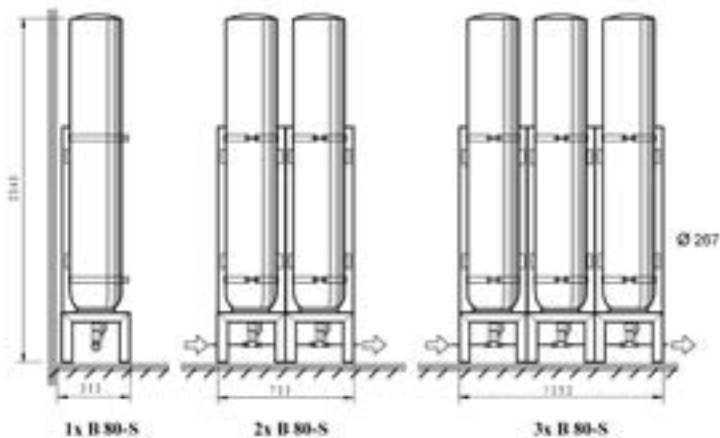

Storage volume	Rated pressure	Weight	Storage capacity	Order number
Litre	bar	kg	Litre/bar	
80	330	approx. 145	24,000 / 300	128860
Optional				
Connecting line				076387

STORAGE BATTERY, B80-B

The modules are intended for operation without safety valve, without pressure gauge, without console and without condensate drain.

THE PRESSURE VESSELS MEET THE REQUIREMENTS OF GERMAN REGULATIONS GOVERNING STATIONARY INSTALLATION.

TECHNICAL DATA

- › **Volume:** 80-litre upright modules with connection at top, without console and without condensate drain
- › **Pressure:** 330 bar
- › **Pipe connection:** for lines with \varnothing 8 mm
- › **Connection dimension in:** R 3/8
- › **Connection dimension out:** M 16 x 1.5

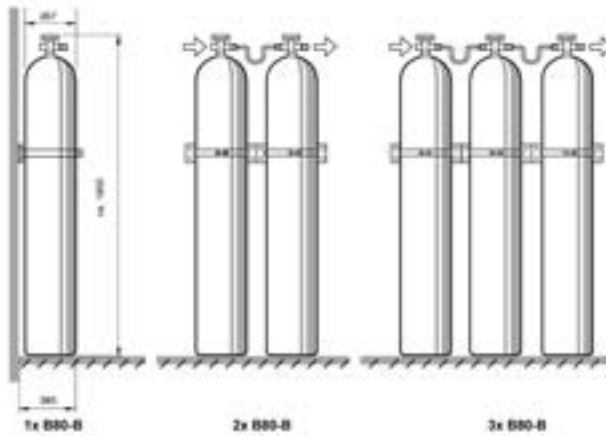

Storage volume	Rated pressure	Weight	Storage capacity	Order number
Litre	bar	kg	Litre/bar	
80	330	approx. 125	26,400 / 330	076356
Optional				
Wall attachment				076355
Connecting line				076363

FILLING VALVES

Our filling valves ensure the greatest possible operational safety, ease of use and long service life.

The lever filling valves as well as rotary wheel valves are safety filling valves. They prevent uncontrolled whipping around of the filling hose if the cylinder is not connected and the filling valve is opened inadvertently. This significantly reduces the risk of accident!

There is no possibility of mixing up the 200 and 300 bar connectors, because: 200 bar connectors are marked in black and do not have a pin on the pressure outlet! 300 bar connectors are marked in red and have a pin on the pressure outlet!

HAND WHEEL VERSION

Opening and venting with one handwheel (internal venting). Valve seat is protected against damage caused by overtightening when closing. Particularly well-suited for mobile use. The complete valve is resistant to corrosion.

LEVER VERSION

Safety filling connection. Unparalleled quality, reliability and operating comfort. Recommended for stationary use, above all on filling panels. Unambiguous lever position OPEN and CLOSED. Integrated silencer. Quieter venting of the valve when removing the compressed air cylinder. The complete valve is resistant to corrosion.

ROTARY WHEEL VERSION

Safety filling connection. Filling valve with integrated check valve. This prevents the residual gas from flowing back into another connected compressed air cylinder. This is advantageous, particularly in precisely calculated NITROX mixtures. When the valve is removed after filling, it is vented automatically by opening the rotary wheel (internal venting). This ensures reliable decoupling from the connected compressed air cylinder. The ergonomic advantages were the main aspect in developing this variant.

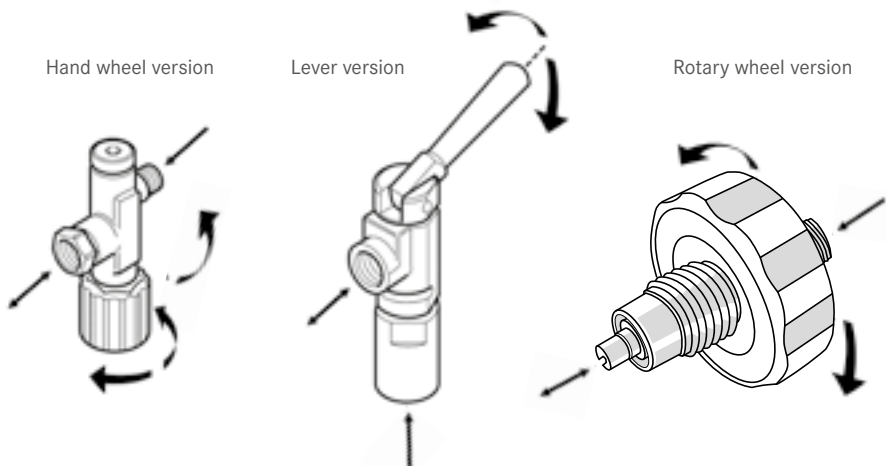

FILLING VALVES

THE ADVANTAGES OF THE NEW LEVER FILLING VALVES

The pressure release reduces the noise by more than half (16 dBA). The frequency of the blow-off sound is low, more pleasant and tolerable for the human ear. In addition, the low residual noise and the surplus air are channelled to the outside via a G1/8 connection. Completely reverse-compatible, it can be exchanged for older versions without difficulty. Many spare parts can be obtained separately, as can the appropriate maintenance kits. Absolutely rust-free. Suitable for continuous use.

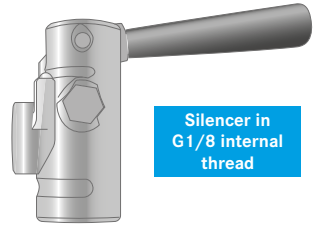

without pressure gauge

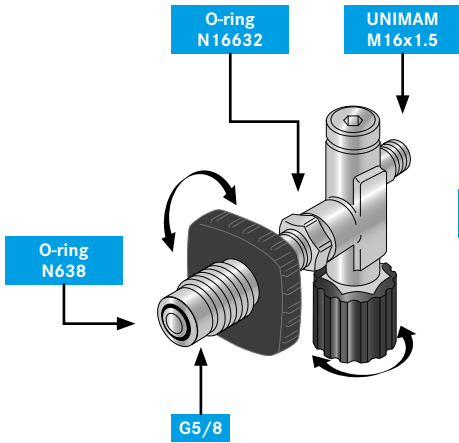

with pressure gauge

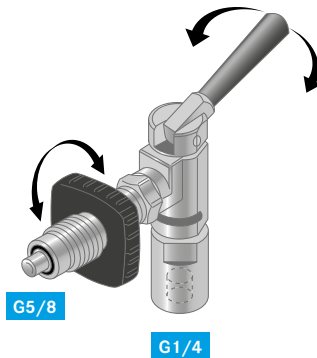
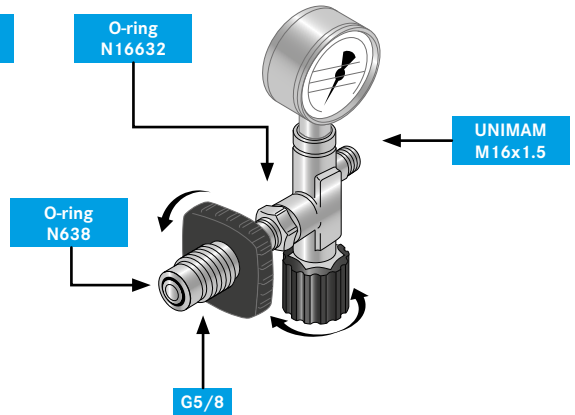

FILLING CONNECTORS

The standardised filling connections (EN 144-2) are available in the variants PN200 bar and PN300 bar for breathing air and as Nitrox version.

FILLING CONNECTION IN RED

› for 300 bar breathing air



FILLING CONNECTION IN BLACK

› for 200 bar breathing air



FILLING CONNECTION IN GREEN

› for 200 bar nitrox

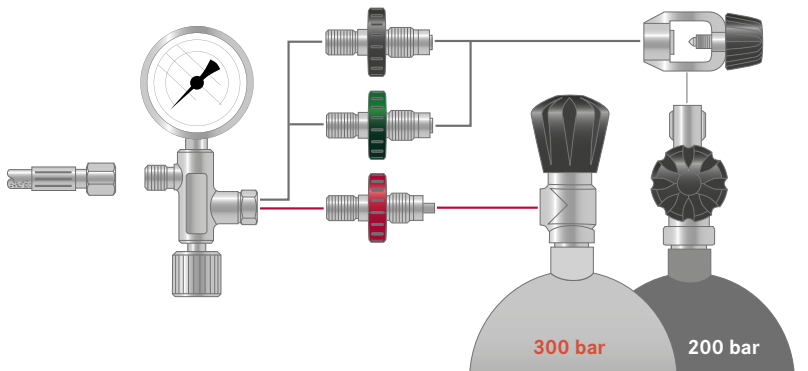

CYLINDER CONNECTOR WITH SPIN VALVE

➤ A filling valve with integrated check valve prevents the residual gas in the compressed air cylinder from flowing back into other connected cylinders. This is advantageous especially with precisely calculated Nitrox mixtures.

FILLING CONNECTION WITH SIMPLE VENT FUNCTION

➤ When the valve is removed after filling, the valve is automatically vented by turning the valve, and safe removal of the filling valve from the cylinder is possible.

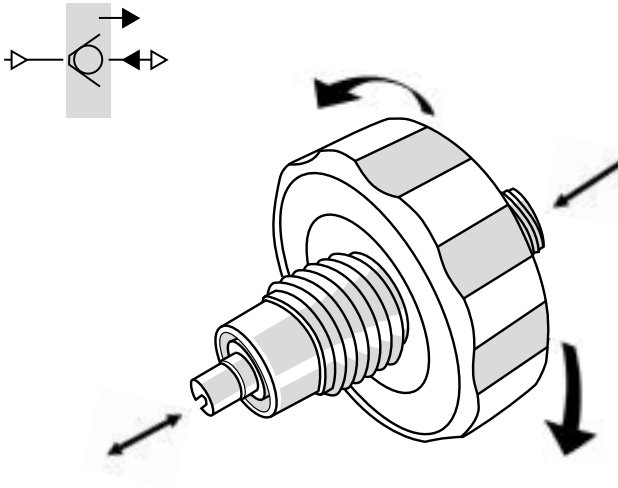

FILLING VALVE THROTTLE INSERT

To meet the requirements of manufacturers of composite cylinders (CFP), installing a cylinder connection piece with integrated throttle insert limits the filling speed when filling breathing air cylinders to approx. 30 bar/min. This reduces the heating of the cylinders being filled.



Existing cylinder connection piece

TECHNICAL DATA

- › **Permitted operating pressure:** PS 350 bar
- › **Testing over-pressure:** PT 500 bar
- › **Permitted operating temperature:** TS 5-50 °C
- › **Medium:** Air
- › **Filling speed 200 bar:** V 30-35 l/min at 200 bar (into a 7 l cylinder)
- › **Filling speed 300 bar:** V 30-35 l/min at 300 bar (in a 7l cylinder)

SAFETY CYLINDER CONNECTORS

The BAUER safety cylinder connectors reliably prevent uncontrolled whipping of the hoses if the valve is opened inadvertently. The risk of accident is effectively reduced.



FILLING VALVES

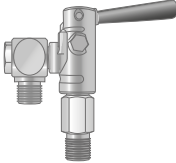
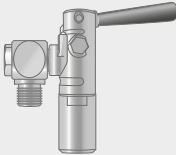
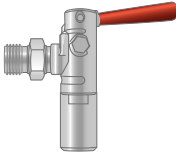

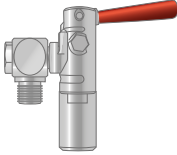
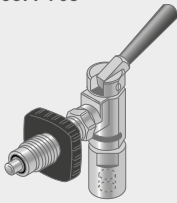
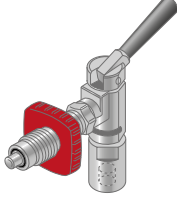
Product reference	Toggle filling valve (stationary) Connector piece thread in valve M 16x1.5	Appropriate accessory or replace- ment part	Order number	Im- age on page 53
86327-F03 	200/300bar for filling hose, with silencer, moveable angle piece, input R3/8" male thread, black lever	Angle piece	072539	6
		Angle piece with nozzle	72539-S01	6
		O-ring between angle piece/valve	N3355	26
		O-ring in angle piece 2x	N18334	25
		Sinter silencer	N29042	29
		Black lever	11322	
		Double nipple R3/8" external thread	11321	17
		Clamping bracket	6942	21
		Washer	N2862	22
		Spring washer	N108	23
		Nut	N57	24
		Sinter filter for 11321	63832	
		O-ring	N3331	
		86102-F03 	200/300 bar, for filling hose, with silencer, with moveable el- bow, 1/4" female thread orifice, black lever	Angle piece
Angle piece with nozzle	72539-S01			6
O-ring between angle piece/valve	N3355			26
O-ring in angle piece 2x	N18334			25
Sinter silencer	N29042			29
Black lever	11322			
Screw-in part 1/4" internal thread	11347			15
Clamping bracket	6942			21
Washer	N2862			22
Spring washer	N108			23
Nut	N57			24
Sinter filter for 11347	63832			
O-ring	N3331			
122361-F03 	200/300 bar, for filling hose, with silencer, with straight con- nector, input 1/4" female thread orifice, red lever			Straight connector with filter
		Straight connector with filter + nozzle	85971	13
		Sinter filter in connector	76386	
		O-ring to valve	N3355	
		Sinter silencer	N29042	29
		Red lever	11322-S01	
		Screw-in part 1/4" internal thread	11347	15
		Clamping bracket	6942	21
		Washer	N2862	22
		Spring washer	N108	23
		Nut	N57	24
		Sinter filter for 11347	63832	
		O-ring	N3331	

Product reference	Toggle filling valve (stationary) Connector piece thread in valve M16x1.5	Appropriate accessory or replace- ment part	Order number	Im- age on page 53		
072832-S01	 <p>200/300 bar, for filling hose, with silencer, with moveable el- bow, 1/4" female thread orifice, red lever</p>	Angle piece	072539	6		
		Angle piece with nozzle	72539-S01	6		
		O-ring between angle piece/valve	N3355	26		
		O-ring in angle piece 2x	N18334	25		
		Sinter silencer	N29042	29		
		Red lever	11322-S01			
		Screw-in part 1/4" internal thread	11347	15		
		Clamping bracket	6942	21		
		Washer	N2862	22		
		Spring washer	N108	23		
		Nut	N57	24		
		Sinter filter for 11347	63832			
		O-ring	N3331			
		85877-F03	 <p>200 bar with direct connection, with silencer, input 1/4" female thread, non-return function, black handwheel 5/8", black lever</p>	Cap, 5/8"	63592	
				Retainer chain for cap	063691	
Connection fitting	077445			1		
Handwheel black	10859					
O-ring to bottle	N638					
O-ring to valve	N3355					
Sinter silencer	N29042			29		
Screw-in part 1/4" internal thread	11347			15		
Clamping bracket	6942			21		
Washer	N2862			22		
Spring washer	N108			23		
Nut	N57					
Sinter filter for 11347	63832					
O-ring	N3331					
Counternut M16x1.5	64279					
85878-F03	 <p>300 bar with direct connection, with silencer, input 1/4" female thread, non-return function, red handwheel 5/8", black lever</p>	Cap, 5/8"	63592			
		Retainer chain for cap	063691			
		Connection fitting	077441	2		
		Handwheel, red	11355			
		O-ring to bottle	N638			
		O-ring to valve	N3355			
		Sinter silencer	N29042	29		
		Screw-in part 1/4" internal thread	11347	15		
		Clamping bracket	6942	21		
		Washer	N2862	22		
		Spring washer	N108	32		
		Nut	N57	24		
		Sinter filter for 11347	63832			
		O-ring	N3331			
		Counternut M16x1.5	64279			

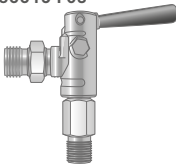
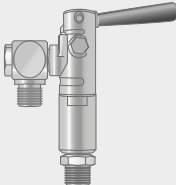
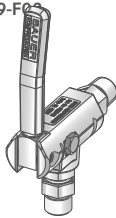
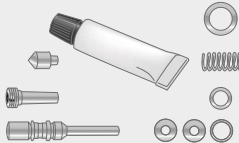

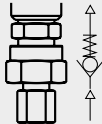
FILLING VALVES

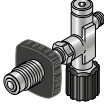
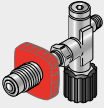

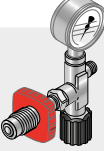
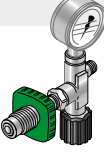
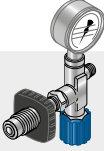
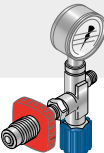
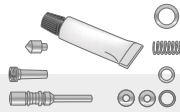
Product reference	Toggle filling valve (stationary) Connector piece thread in valve M 16x1.5	Appropriate accessory or replace- ment part	Order number	Im- age on page 53
86615-F03	 <p>200/300bar for filling hose, with silencer, with straight connector, conic intake R3/8" external thread, Black lever Specially designed for: VERTICUS and MINI-VERTICUS</p>	<p>Straight connector with filter Straight connector with filter + nozzle O-ring to valve Sinter silencer Black lever Screw-in unit R3/8" external thread Teflon sealing strip</p>	<p>076421 85971 N3355 N29042 11322 86616 N19943</p>	<p>13 13 29</p>
85622-F03	 <p>200/300 bar for filling hose, with silencer, with moveable elbow, input with check valve for 6mm pipe inlet M14x1.5 (6S), check valve is screwed in at the bottom of input piece 11347</p>	<p>Identical accessories as e.g. for 86102-F03 Otherwise, e.g. also: Check valve Adjustable T-piece M14x1.5 Lock nut 6S= M14x1.5 Cutting ring 6S CFA pipe 6x1</p>	<p>N29420 N20019 N3610 N3663 N3616</p>	<p>13 13 29</p>
176869-F03	 <p>200/300bar for filling hose, with silencer, with straight connector, conic intake R3/8" external thread, Black lever Specially designed for: new VERTICUS and new MINI-VERTICUS</p>	<p>Straight connector with filter Straight connector with filter + nozzle O-ring to valve Sinter silencer Black lever Screw-in unit R3/8" external thread Teflon sealing strip</p>	<p>076421 85971 N3355 N29042 11322 86616 N19943</p>	<p>13 13 29</p>
85622-F03		<p>Repair or maintenance kit: until 1997 N5052 until 2006 N6676 2007 or later N29617 From 2007 for NITROX N30890</p>		<p>20</p>

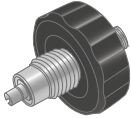
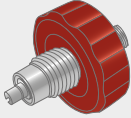
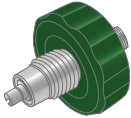

Product reference	Filling valve (mobile) with UNIMAM input Connector piece thread in valve 1/4"	Appropriate accessory or replacement part	Order number	Image on page 53
071744	 200 bar without pressure gauge, black handwheel 5/8"	Connector piece with black handwheel O-ring to bottle O-ring to valve Counternut 1/4"	064698 N638 N16632 64289	19
071743	 300 bar without pressure gauge, red handwheel 5/8"	Connector piece with red handwheel O-ring to bottle O-ring to valve Counternut 1/4"	064699 N638 N16632 64289	18
071343	 200 bar with pressure gauge, black handwheel 5/8"	Connector piece with black handwheel O-ring to bottle O-ring to valve Pressure gauge Rubber protection Counternut 1/4" Replacement glass	064698 N638 N16632 N1315 N15985 64289 N19954	19
071344	 300 bar with pressure gauge, red handwheel 5/8"	Connector piece with red handwheel O-ring to bottle O-ring to valve Pressure gauge Rubber protection Counternut 1/4" Replacement glass	064699 N638 N16632 N4101 N15985 64289 N19954	18
83935	 200 bar with pressure gauge, green handwheel M26x2 NITROX	Connector piece with green handwheel O-ring to bottle O-ring to valve Pressure gauge Rubber protection Counternut 1/4" Replacement glass	83870 N16057 N16632 N1315 N15985 64289 N19954	
79193	 200 bar with pressure gauge, without venting, blue control valve, black handwheel 5/8" Shooting sports	Connector piece with black handwheel O-ring to bottle O-ring to valve Pressure gauge Rubber protection Counternut 1/4" Replacement glass	064698 N638 N16632 N1315 N15985 64289 N19954	19
79197	 300 bar with pressure gauge, without venting, blue control valve, Red handwheel 5/8" Shooting sports	Connector piece with red handwheel O-ring to bottle O-ring to valve Pressure gauge Rubber protection Counternut 1/4" Replacement glass	064699 N638 N16632 N4101 N15985 64289 N19954	18
		Repair or maintenance kit: until approx. 1993 from approx. 1993 only shooting sports	N5051 072349 164816	20

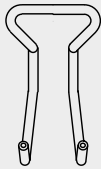

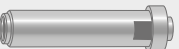
FILLING VALVES

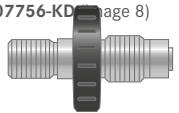
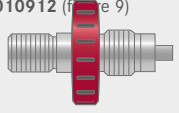





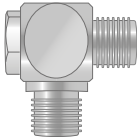
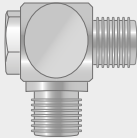
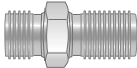
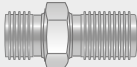
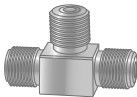
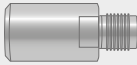
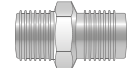

Product reference	Filling valve (mobile) with UNIMAM input	Appropriate accessory or replacement part	Order number
125085 (figure 28)	200bar quick-venting, black handwheel 5/8"	Locking ring O-ring to bottle O-ring in valve 2x	N38010 N638 N25452
			
125083 (figure 28)	300bar quick-venting, Red handwheel 5/8"	Locking ring O-ring to bottle O-ring in valve 2x	N38010 N638 N25452
			
125085 (figure 28)	200bar quick-venting, Green handwheel M26x2 NITROX	Locking ring O-ring to cylinder O-ring in valve 2x	N38010 N16057 N25452
			
176805	300bar, comprising 176893 UNIMAM filling connector and 177865 red handwheel	O-ring to cylinder	N638
			
176850	200bar, comprising 176886 UNIMAM filling connector and 177876 black handwheel of the new VERTICUS	O-ring to bottle	N638
			
73945	Hanging bracket for filling connection. Attached by means of 2 screws to filling panels present, or to other adequate locations. Only suitable for filling connectors with handwheels!	Hexagonal bolt M8x20 Hexagonal bolt M8x25 Nut U-washer, small U-washer, large U-washer, thick Spring washer	N19505 N19506 N57 N58 N2460 N2862 N108
			
NIRO			

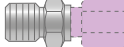
Product reference	Diverse filling connectors	Appropriate accessory or replacement part	Order number
129092	 <p>200bar cylinder connection piece for all lever filling valves, with including throttle insert for CFK cylinders, non-return function, no handwheel Connector piece thread M16x1.5</p>	Black handwheel O-ring to bottle O-ring to valve Counternut M16x1.5	10859 N638 N3355 64279
128452	 <p>300bar cylinder connection piece for all lever filling valves, with including throttle insert for CFK cylinders, Non-return function, without handwheel Connector piece thread M16x1.5</p>	Red handwheel O-ring to bottle O-ring to valve Counternut M16x1.5	11355 N638 N3355 64279
077445	 <p>200bar cylinder connection piece for all lever filling valves, with non-return function, without handwheel Connector piece thread M16x1.5</p>	Black handwheel O-ring to bottle O-ring to valve Counternut M16x1	10859 N638 N3355 64279
064689	064689: As above but without non-return function		
077441	 <p>300bar cylinder connection piece for all lever filling valves, with non-return function, without handwheel Connector piece thread M16x1.5</p>	Red handwheel O-ring to bottle O-ring to valve Counternut M16x1.5	11355 N638 N3355 64279
064699	064699: As above but without non-return function		
07756-KD (page 8)	 <p>200bar cylinder connector 5/8" with M16x1.5 UNIMAM hose intake, with non-return function, black handwheel</p>	Black handwheel O-ring to bottle O-ring on UNIMAM hose	10859 N638 N16632
010912 (page 9)	 <p>300bar cylinder connector 5/8" with M16x1.5 UNIMAM hose intake, with non-return function, red handwheel</p>	Red handwheel O-ring to bottle O-ring on UNIMAM hose	11355 N638 N16632
83974 (page 10)	 <p>200bar cylinder connector M26x2 with M16x1.5 UNIMAM hose intake, with non-return function, green handwheel NITROX</p>	Green handwheel O-ring to bottle O-ring for UNIMAM	83867 N16057 N16632

FILLING VALVE ACCESSORIES

Product reference	Diverse filling connectors	Appropriate accessory or replacement part	Order number
03147 (figure 11)	200bar international cylinder connection, 16x1.5 UNIMAM hose	O-ring in connector UNIMAM filling hoses in diverse lengths. From 0.5 to 80 metres. In different metre-based lengths	N638 e.g. 1m N2817 2m N2818
79375 (figure 12)	200bar international cylinder connection, 5/8" internal thread input	O-ring in connector UNIMAM filling hoses in diverse lengths. From 0.5 to 80 metres. In different metre-based lengths	N638 e.g. 1m N2817 2m N2818
83799	300bar cylinder connection piece, UNIMAM hose input angled 90°, only for Interspiro breathing air cylinders! Red handwheel	O-ring to bottle O-ring in connector O-ring in connector 2x Red handwheel UNIMAM filling hoses in diverse lengths. From 0.5 to 80 metres. In different metre-based lengths	N638 N2814 N1338 N1355 e.g. 1m N2817 2m N2818
83225	300bar cylinder connection piece, UNIMAM hose intake, non-return function, only for Interspiro breathing air cylinders without handwheel Connector piece thread M16x1.5	O-ring Red handwheel Counternut M16x1.5 UNIMAM filling hoses in diverse lengths. From 0.5 to 80 metres. In different metre-based lengths	N638 N1355 64279 e.g. 1m N2817 2m N2818
5951 (figure 3)	200bar adapter UNIMAM hose to 5/8" female thread	UNIMAM filling hoses in diverse lengths. From 0.5 to 80 metres. In different metre-based lengths	e.g. 1m N2817 2m N2818
11255 (figure 4)	300bar adapter UNIMAM hose to 5/8" female thread	UNIMAM filling hoses in diverse lengths. From 0.5 to 80 metres. In different metre-based lengths	e.g. 1m N2817 2m N2818
068870	300bar adapter UNIMAM hose on M16x1.5 old 60° filling connector	UNIMAM filling hoses in diverse lengths. From 0.5 to 80 metres. In different metre-based lengths	e.g. 1m N2817 2m N2818

Product reference	Diverse filling connectors	Appropriate accessory or replacement part	Order number
072539 (figure 6) 	200/300bar, moveable angle connector, for lever filling valves UNIMAM outlet	O-ring to valve O-ring in connector 2x	N3355 N18334
72539-S01 (Fig. 6) 	200/300bar, moveable angle connector, for lever filling valves, UNIMAM outlet, with throttle nozzle for CFK bottles	O-ring to valve O-ring in connector 2x Sintered filter	N3355 N18334 76386
076421 (figure 13) 	200/300bar, Straight connector, for lever filling valves, UNIMAM outlet	O-ring to valve Counternut M16x1.5	N3355 64279
85971 (figure 13) 	200/300bar, Straight connector, for lever filling valves, UNIMAM outlet, with throttle nozzle for CFK cylinders	O-ring to valve Counternut M16x1.5	N3355 64279
171894 (figure 14) 	200/300bar, T-piece, central thread R1/4", male thread 2x M14x1.5, for lever filling valve, with throttle nozzle for CFK cylinders, Connection of WEH couplings	Teflon sealing strip	N19943
11347 (figure 15) 	200/300bar, Input piece for lever filling valves, without sinter filter, Internal thread IG=G1/4", external thread AG=G3/8"	O-ring to valve Sintered filter	N3331 63832
75311 (figure 16) 	200/300bar, conical input piece for lever fill- ing valve, AG=R3/8", AG=G3/8" to valve	O-ring to valve Teflon sealing strip	N3331 N19943
11321 (figure 17) 	200/300bar, input piece for lever filling valve, AG=G3/8", AG=G3/8"	O-ring to valve	N3331
63596 (figure 5) 	200/300bar, straight connection with conical hose outlet 60° for lever filling valves, no UNIMAM	O-ring to valve	N3355

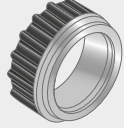
Product reference	Diverse filling connectors	Appropriate accessory or replacement part	Order number
Fig. 7	 <p>Custom-made products 200/300bar, custom screw connections, on request.</p>	Notes:	
86616	 <p>Connection nipple, thread to filling valve G3/8" bottom, on other side R3/8" NIRO</p>	Teflon sealing strip	N19943
79330	 <p>200bar adapter 5/8" to 5/8" female thread</p>	<p>Useful information! Thread designation G = straight Thread designation R = conical</p>	
66939	 <p>300bar adapter 5/8" to 5/8" female thread</p>		
160728	 <p>200/300bar, hose manifold single., also called a Y-piece, 2x 60° hose connection, 1x M16x1.5 union nut fitting 78801</p>	Y-piece and 58036 (nipple with seal, complete)	073080-KD
78801	 <p>200/300bar, hose nipple, single, G1/4" external thread to 60° hose connection, non- UNIMAM</p>	Nipple 78801 and seal, complete	ED seal N25108, 58036
78803	 <p>200/300bar, hose nipple, single, G1/4" external thread to UNIMAM hose connection</p>	Nipple 78803 and seal, complete	ED seal N25108, 65363, N25108
N1315	 <p>200bar pressure gauge with R1/4" thread at bottom, no glycerine filling, 64mmØ Red marking at 225bar</p>	Teflon sealing strip Replacement glass	N19943 N19954
N4101	 <p>300bar pressure gauge with R1/4" thread at bottom, no glycerine filling, 64mmØ Red marking at 330bar</p>	Teflon sealing strip Replacement glass	N19943 N19954
N15985	 <p>Black rubber protector cap for filling valves with 63Ø thread below</p>		

Attention! All images are for illustrative purposes only and may differ from the original!

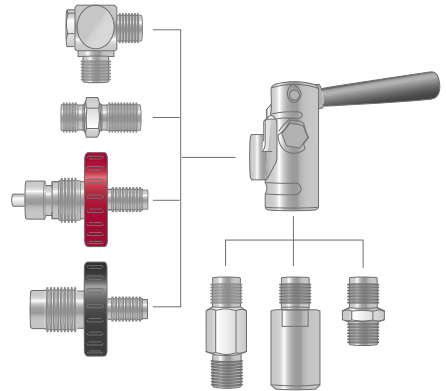
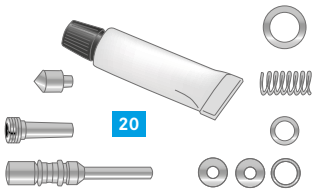
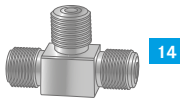
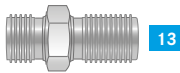
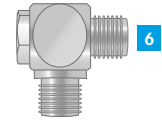
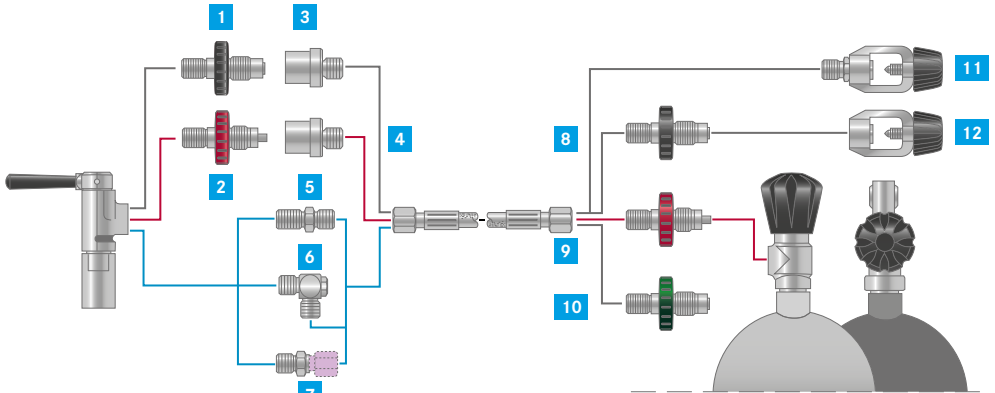

Repair, maintenance, angled connection

O-rings required:

25=N18334

26=N3355

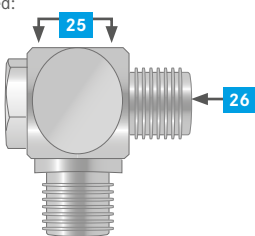

Fastening parts for filling panel assembly.

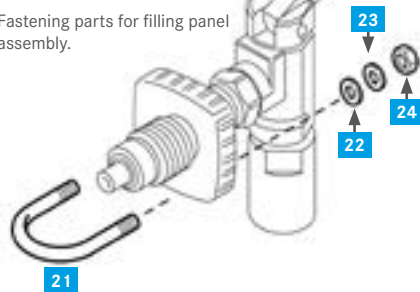

DISTRIBUTION CONNECTORS

Required if the compressor is only equipped with one filling connector and a further filling possibility is required.

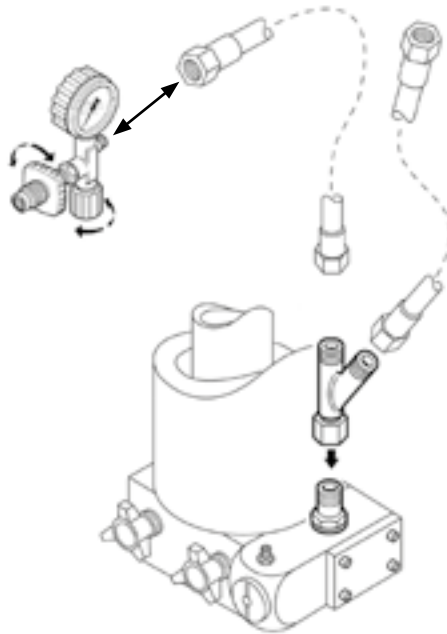

TECHNICAL DATA

- ▶ Maximum pressure: 350 bar

Designation

Y-distributor

Order number

160728

DISTRIBUTION CONNECTORS EXPANSION

Distribution connector for two further connection/filling possibilities.
Installation on pressure retention/check valve

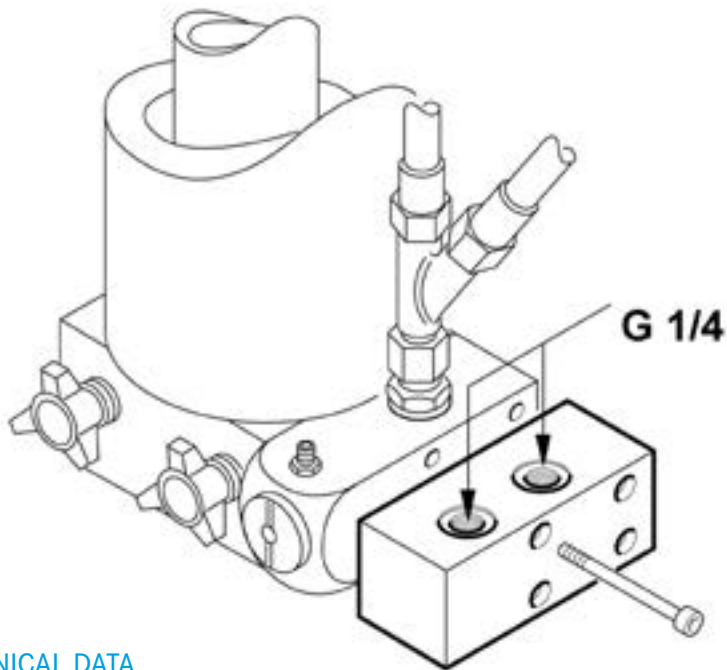

TECHNICAL DATA

- › Maximum pressure: 350 bar

SCOPE OF DELIVERY

- › Distributor piece
- › 4 Allen screws M 6 x 80

Designation

Distributor block complete, for 2 additional connectors

Order number

58968-KD

CHECK VALVES

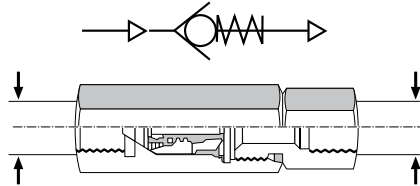

Designation	Operating pressure	Connections	Nominal width	Air flow rate ¹	Order number
	bar / max.		mm	m ³ /min.	
Check valve	450	2 x G 1/4	6	1	N1463

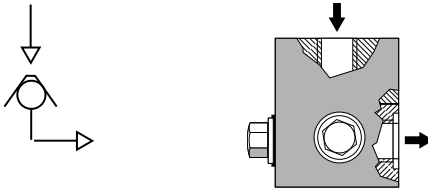

Designation	Operating pressure	Connections	Nominal width	Air flow rate ¹	Order number
	bar / max.		mm	m ³ /min.	
Check valve	350	2 x pipe ø 12	5	3	061843

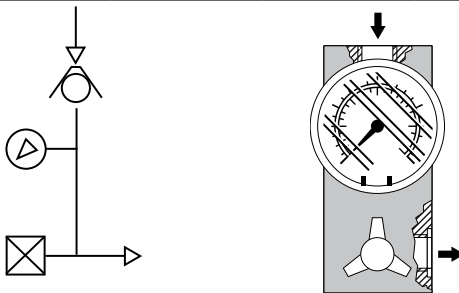

Designation	Operating pressure	Connections	Nominal width	Air flow rate ¹	Order number
	bar / max.		mm	m ³ /min.	
Check valve with pressure gauge and bleed	350	2 x G 3/8	5	3	064547

¹ The specified air flow rate relates to a flow speed of 15 m².

QUICK-ACTION COUPLINGS

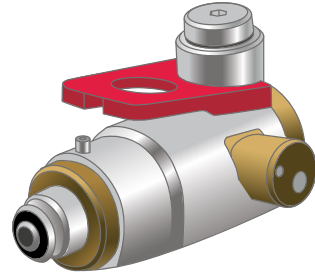
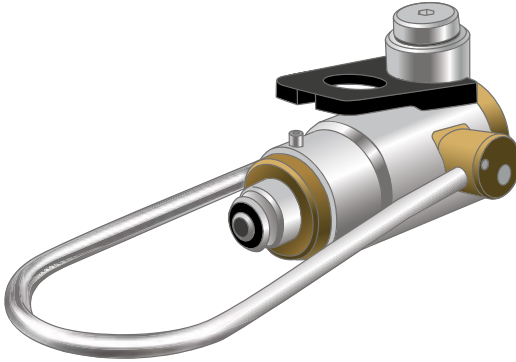

PN200 quick-action coupling for lever filling valves

Outlet	G 5/8
Inlet	NS-1"-14 external
Pressure range	PN200
Application	For conversion for filling panel equipped with screw adapters; enables connection within seconds directly to the standard thread of the cylinder valve.

Safety bracket 72 (short)

Spare part no. N27188

PN300 quick-action coupling for lever filling valves

Outlet	G 5/8
Inlet	NS-1"-14 external
Pressure range	PN300
Application	For conversion for filling panel equipped with screw adapters; enables connection within seconds directly to the standard thread of the cylinder valve.

Safety bracket 72 (short)

Spare part no. N27194

PN200 quick-action coupling for hose connection

Outlet	G 5/8
Inlet	M 16x1.5
Pressure range	PN200
Application	As for PN200 quick-action coupling, additional feed from below for standards-compliant connection of the BAUER hose.

Standard safety bracket 1 (long)

Spare part no. N30505

PN300 quick-action coupling for hose connection

Outlet	G 5/8
Inlet	M 16x1.5
Pressure range	PN300
Application	As for PN300 quick-action coupling, additional feed from below for standards-compliant connection of the BAUER hose.

For Interspiro cylinders

Spare part no. N32165

PN200 quick-action coupling for straight hose connection

Outlet	G 5/8
Inlet	M 16x1.5
Pressure range	PN200
Application	As for PN200 quick-action coupling with straight hose feed from the rear for connecting a BAUER hose

Standard safety bracket 72 (short)

Spare part no. N30578**PN300 quick-action coupling for straight hose connection**

Outlet	G 5/8
Inlet	M 16x1.5
Pressure range	PN300
Application	As for PN300 quick-action coupling with straight hose feed from the rear for connecting a BAUER hose

Standard safety bracket 72 (short)

Spare part no. N30579**PN200 quick-action coupling for hose connection**

Outlet	G 5/8
Inlet	M 16x1.5
Pressure range	PN200
Application	As for PN200 quick-action coupling, additional feed from above for standards-compliant connection of a BAUER hose.

For Interspiro cylinders

Spare part no. N32 164**Connection adapter**

Outlet	NS-1"-14 internal
Inlet	M 16x1.5 external
Pressure range	PN 200/300
Application	Required for assembly of quick-action couplings PN 220 & PN 300 on filling panels incl. 2 o-rings & 1 clamping nut

Spare part no. N27 189**Height equalisation**

Application	Weight and height equalisation system for secure positioning of the cylinders underneath the filling panel
-------------	--

Spare part no. N27 190**Set 1: PN 200 quick-action coupling set**

Comprising	1 x PN 200 quick-action coupling (N27 188) 1 x adapter (N27 189) 1 x height equaliser (N27 190)
------------	---

Spare part no. 87271**Set 2: PN 300 quick-action coupling set**

Comprising	1 x PN 300 quick-action coupling (N27 194) 1 x adapter (N27 189) 1 x height equaliser (N27 190)
------------	---

Spare part no. 87272

Front gasket for quick-action coupling

Spare part no. N30969

FILLING STATIONS

Filling stations are used for quick and economical filling of breathing air cylinders. The modular design of all panels, the controls and even the filling connectors mean that BAUER KOMPRESSOREN can provide a tailor-made solution for any situation and adapt to your particular requirements.

Please observe the relevant installation regulations!

The filling panel is installed separately from the system. In "open" systems – ones without acoustic insulation – and when spatial separation is required, i.e. the filling panel may be installed in a separate room.

Selection of alternative models of BAUER filling panels

Whichever filling panel you choose, the BAUER filling station consists of tried-and-tested components that offer you the highest possible safety and a particularly high level of convenience. We will be happy to help you assemble your filling station according to your individual wishes.

Not only the delivery rate of your compressor but also the number of cylinders filled per day, the required speed and available space are important design parameters.

BAUER KOMPRESSOREN has the optimum solution ready for every requirement.

On the following pages, you can find an overview of the installation possibilities and main components from compressor and purification up to storage and distribution.

A detailed description of the possible combinations of control modules and filling panels is presented for you on the following pages.

EXAMPLES OF COMPRESSED AIRLINES

The corresponding compressed airlines show you alternative installation possibilities.
The item numbers refer to the description on the following pages.

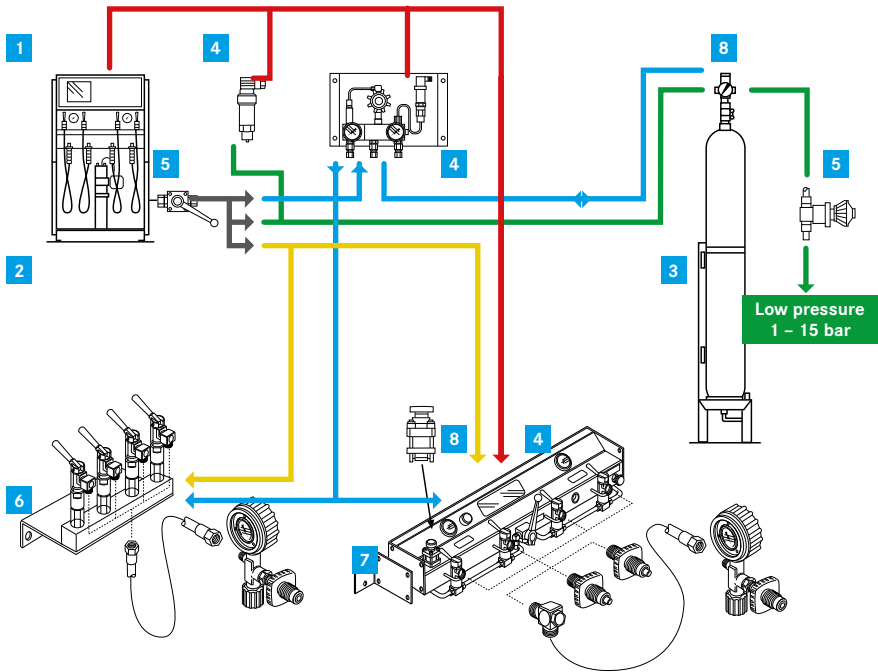

1. Compression
2. Purification
3. Storage
4. Controlling automatically
5. Regulating manually
6. Distributing compact
7. Distributing convenience
8. Safety valve

Automatic selector unit
Pressure regulator
Direct filling
Controlling, regulating, monitoring

FILLING STATIONS

OVERVIEW: THE COMPONENTS OF THE SYSTEM, THE CONTROL AND ALTERNATIVELY COMBINABLE MODELS OF FILLING PANELS.

COMPRESSING AND PURIFYING

High-pressure compressor unit (1) complete with filter system (2) and safety valve.

We recommend the system with automatic condensate drain and compressor control so that unsupervised compressor operation is possible.

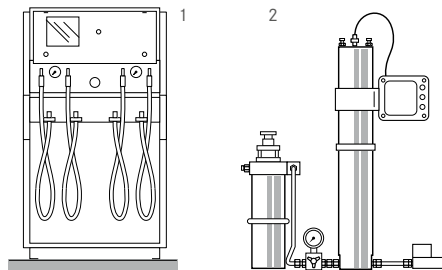

STORAGE

Cylinder battery (3) to provide an adequate amount of compressed air, see Storage chapter.

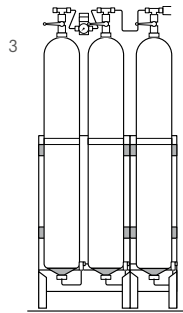

CONTROLLING AUTOMATICALLY

Automatic selector unit (4). The advantage of storage bottles can only be used optimally in this way. The automatic unit consists of a pressure retention and check valve with integrated pressure switch or pressure sensor that switches the compressor unit on or off in each case. Using this automatic unit makes a cascade filling connection superfluous.

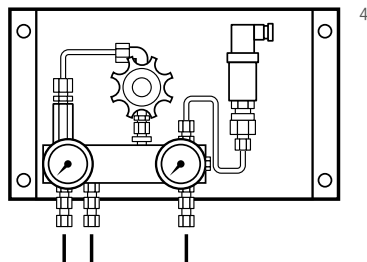

CONTROLLING, MANUALLY

Switch-over valve (5): In this case, it is necessary to switch over the valve manually between the rack of cylinders and the cylinder to be filled after the pressure equalisation has been reached, and for the compressor to be switched on manually. This version is only to be recommended if the system will be operated by trained personnel!

5

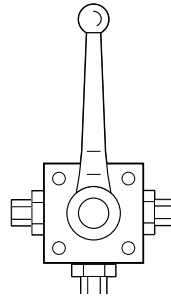

DISTRIBUTION

Distribution panel (6) compact filling panel for mounting on system housings or crash frame. Available from 1-4 filling connectors.

6

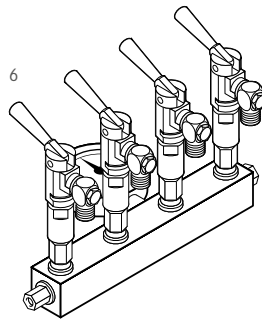

DISTRIBUTION

External filling panel (7): Filling panel with direct connection* for breathing air cylinders or for filling with hose connection possible. Four-way or also six-way connectors available. Optionally, the filling panels are available with safety valve and pressure reducer.

7

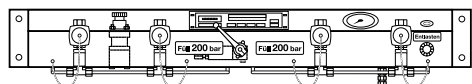

OVERVIEW OF FILLING PANELS – FOR WALL MOUNTING

- › Filling pressure 200 and / or 300 bar
- › Lever filling valves
- › 4 - 6-way filling connectors
- › Connection of filling hoses or direct connection for cylinders (max. 15 kg)
- › Maximum dimensions: 1200 x 138 x 300 mm (with six-way direct connection)
- › Application range for all free air deliveries
- › Application temperature from +5 to +45 °C,
- › Compatible with all units

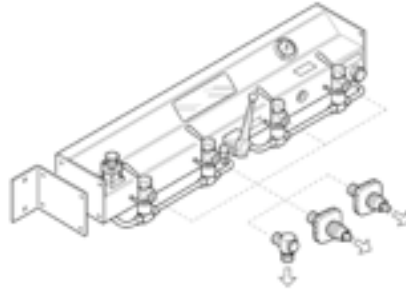

Panel

- › Filling pressure 200 or 300 bar
- › Lever or handwheel filling valves
- › 1 - 4 way filling connectors
- › Connection of filling hoses
- › Maximum dimensions: 239 x 150 x 150 mm (in four-way hose connection with lever filling valves)
- › Safety equipment (see table)
- › Application range for all free air deliveries
- › Application temperature from +5 to +45 °C,
- › Compatible with all units

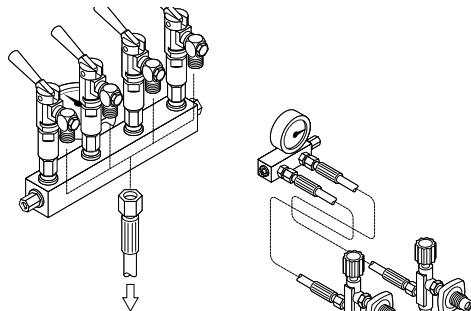

DISTRIBUTION PANEL

TYPE SERIES "EXTERNAL FILLING PANEL"

Complete filling stations are used for quick and efficient filling of breathing air cylinders. The main components are the compressor unit, rack of cylinders, automatic selector unit or switch-over valve and the filling panel (for a detailed description of function, refer to the 'filling stations' chapter).

The external filling panel can be mounted on the wall as a separate filling panel and is also suitable for installation in another room, equipped with remote control.

Please note the various combination options with the automatic selector unit as well as the BAUER B-CONTROL. Refer to the descriptions in the corresponding chapters.

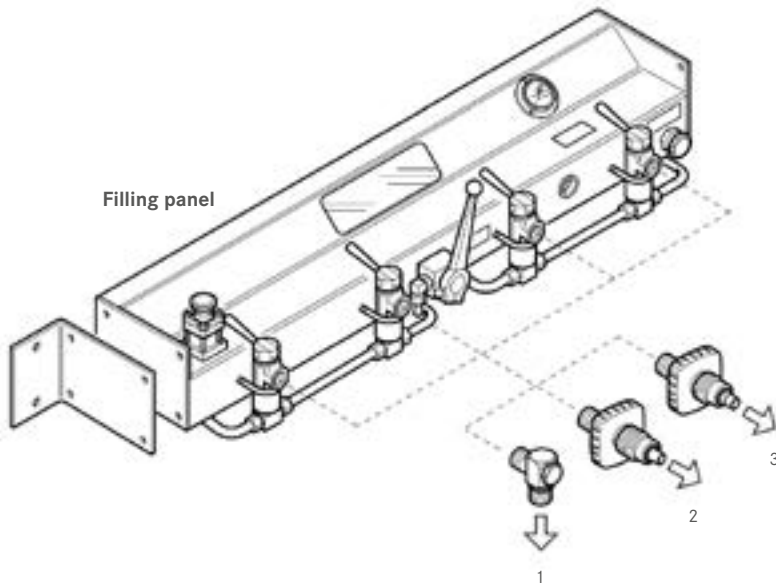

- 1 Hose connector with angle piece
- 2 Cylinder direct connection PN200
- 3 Cylinder direct connection PN300

SELECTION CRITERIA

- Filling valves**
- › Lever
- Dimensions**
- with hose connection**
- › 4-way 1140 x 138 x 250 mm
 - › 6-way 1200 x 138 x 250 mm
- with direct connection**
- › 4-way 1140 x 138 x 300 mm
 - › 6-way 1200 x 138 x 300 mm
- Safety equipment**
- › Safety valve
 - › Pressure sensor
 - › Locking
 - › Pressure reducer or switch-over valve optionally with or without B-CONTROL or pressure gauge
- Area of application**
- › Irrespective of the free air delivery
 - › Compatible with all units
 - › Ambient temperature from +5 to +65 °C

PRODUCT ADVANTAGES

- Design**
- › Extraordinary quality of the panel and the filling valves
- Ergonomics**
- › Tried-and-tested system
- Range of models**
- › Can be expanded as required with additional panels (see table)
- Quality and safety**
- › CE standard
 - › Material protected against corrosion
 - › Possibility of fitting safety valves and pressure reducer
- Combination with filling valves**
- › Large number of different options (see product information on filling valves)
 - › Wide range of models for any application

EXTERNAL FILLING PANELS

Design	SIV 225 bar	B-CONTROL switching panel	Sw.-over valve	Pressure reducer	B-SAFE-compatible	Order number
Without switching panel, with 4 connectors						
200 bar, 4x, hose						068019
300 bar, 4x, hose						068020
200 bar, 4x, hose	●					072590
200/300 bar, 4x, hose	●			●		068025
200 bar, 4x, direct						075026
300 bar, 4x, direct						075030
200 bar, 4x, direct	●					075027
200/300 bar, 4x, direct	●			●		075007
Without switching panel, with 6 connectors						
200 bar, 6x, hose ¹						075031
300 bar, 6x, hose						075035
200 bar, 6x, hose	●				●	066721
200/300 bar, 6x, hose	●			●	●	075039
200 bar, 6x, direct						075040
300 bar, 6x, direct						073740
200 bar, 6x, direct	●				●	075041
200/300 bar, 6x, direct	●			●	●	075011

VERSIONS FOR UNITS WITH B-CONTROL CONTROL SYSTEM

Design	SIV 225 bar	B-CONTROL switching panel	Sw.-over valve	Pressure reducer	B-SAFE-compatible	Order number
With switching panel, with 4 connectors						
200 bar, 4x, hose		●				73083-BC
300 bar, 4x, hose		●				73084-BC
200/300 bar, 4x, hose	●	●		●		73086-BC
200 bar, 4x, direct		●				75029-BC
300 bar, 4x, direct		●				73235-BC
200/300 bar, 4x, direct	●	●		●		75006-BC
With switching panel, with 6 connectors						
200 bar, 6x, hose		●				75033-BC
300 bar, 6x, hose		●				75036-BC
200/300 bar, 6x, hose	●	●		●		73153-BC
200 bar, 6x, direct		●				75043-BC
300 bar, 6x, direct		●				73231-BC
200/300 bar, 6x, direct	●	●		●		75010-BC
With switching panel, with 10 connectors						
200/300 bar, 10x, direct ¹	●	●		●		76769-BC

1 For filling panel with pressure switch, the additional connecting cable N21659 is required

2 Surcharge for additional selection of SECURUS signal lamp

3 Optionally available with cylinder lock.

VERSIONS FOR UNITS WITH CONVENTIONAL (HARD-WIRED) CONTROL SYSTEM

Design	SIV 225 bar	Pressure switch ¹	BHW switching panel ²	Sw.-over valve	Pressure reducer	B-SAFE-compatible	Order number
Without switching panel, with 4 connectors							
200 bar, 4x, hose	●	●					72597-BHW
200/300 bar, 4x, hose	●	●		●			72598-BHW
Without switching panel, with 6 connectors							
200/300 bar, 6x, hose	●	●		●			75038-BHW
200/300 bar, 6x, direct	●	●		●			75009-BHW
With switching panel, with 4 connectors							
200 bar, 4x, hose			●				73083-BHW
300 bar, 4x, hose			●				73084-BHW
200/300 bar, 4x, hose	●		●		●		73086-BHW
300 bar, 4x, direct			●				73235-BHW
200 bar, 4x, direct	●	●	●				73232-BHW
200/300 bar, 4x, direct	●	●	●	●			73236-BHW
200/300 bar, 4x, direct	●		●		●		75006-BHW
With switching panel, with 6 connectors							
300 bar, 6x, hose			●				75036-BHW
200/300 bar, 6x, hose	●		●		●		73153-BHW
200 bar, 6x, direct			●				75043-BHW
300 bar, 6x, direct			●				73231-BHW
200/300 bar, 6x, direct	●		●		●		75010-BHW
With switching panel, with 10 connectors							
200/300 bar, 10x, direct ³	●		●		●		76769-BHW
Without switching panel, with 10 connectors							
200/300 bar, 10x, direct ³	●				●		76769

TECHNICAL DATA

Filling connectors	Dimensions (L × W × H)	Weight
	mm	kg
4 filling valves	1140 × 138 × 183	N/A
6 filling connectors	1200 × 138 × 183	N/A
10 filling connectors	1120 × 352 × 370	33 kg

FILLING PANELS WITH 1 OR 2 CONNECTORS

Design	SIV 225 bar	Pressure reducer	Dimensions (L × W × H)	Order number
			mm	
200 bar, 1 direct filling connection	■	■	135 x 196 x 140	166313
300 bar, 1 direct filling connection	■	■	135 x 196 x 140	169461
200 bar, 1 direct filling connection ¹	●	●	446 x 296 x 160	166314
200/300 bar, 2 direct filling connections	●	●	446 x 296 x 160	170957

¹ 300 bar version on request.

DISTRIBUTION PANELS COMPACT

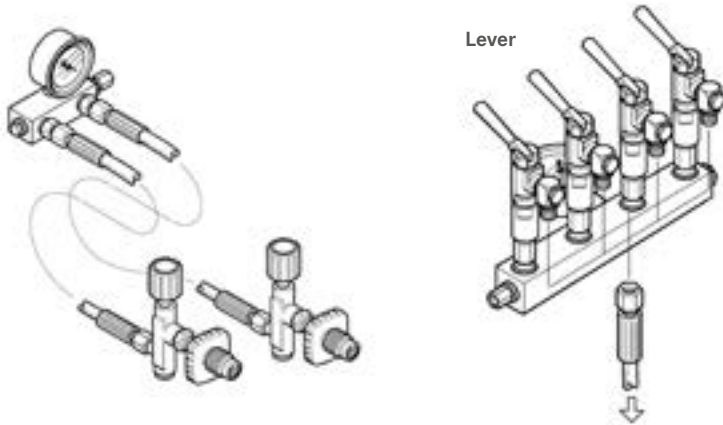

- › **Design:** Compact. Ideal for subsequent installation on compressors, mobile devices or also on ships, because of the low space requirement.
- › **Models:** 1 - 4-way filling connections optionally with handwheel valves or lever.
- › **Quality:** CE standard, corrosion-resistant material.
- › **Filling pressure:** 225 or 330 bar
- › **Safety:** All panels are equipped with a 600 bar pressure gauge for quick checking.
- › **Area of application:** Irrespective of the delivery rate, compatible with all compressors, temperature range +5 °C to +45 °C
- › **Dimensions:** Handwheel version from 109x150x80 mm to 239x115x80 mm (LxHxD) lever version from 109x150x150 mm to 239x150x150 mm (LxHxD)
- › **Installation:** The panels have internal threads on the back (M8). This means they can be mounted on system housings, crash frames or any suitable points.
- › **Pressure inlet:** 1/4" internal thread provided with a screw-in fitting for 8mm pipe Ø.
- › **Scope of delivery:** All distribution panels are supplied with distributor block, filling valves, pressure gauge and UNIMAM filling hoses (1000 mm).
- › **Flexibility:** Can be expanded with other BAUER KOMPRESSOREN products.

Article order number for the 16 available products: see table

YOUR PRODUCT ADVANTAGES AT A GLANCE

DESIGN

- › Simplest possible design
- › Compact, especially for subsequent mounting on systems
- › Ideal for ships and other mobile stations where space is at a premium

RANGE OF MODELS

- › Large number of different equipment variants (see table)

QUALITY AND SAFETY

- › Extraordinary quality of the filling valves (see table)
- › Material protected against corrosion
- › CE standard
- › Equipment with safety valves
- › and pressure reducer

COMBINATION WITH FILLING VALVES

- › Large number of different options (see product information on filling valves)
- › wide range of models for any application

DISTRIBUTION PANEL WITH HOSE CONNECTION

for mounting on portable breathing air compressors (with crash frame)

Filling pressure bar	System pressure bar / max.	Type of filling valve	Order numbers			
			With one filling connector	With 2 filling connectors	With 3 filling connectors	With 4 filling connectors
200	225	Lever	073519	073520	073208	073521
300	330	Lever	073956	073957	073958	073959
200	225	Handwheel	074962	074963	074964	074965
300	330	Handwheel	074966	074967	074968	074969

Equipment: All distribution panels consist of distributor block, filling valve, filling hose and pressure gauge.

AUTOMATIC SELECTOR UNIT

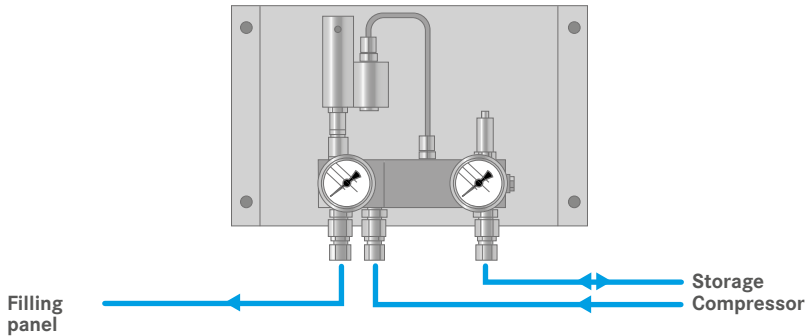

BENEFITS TO YOU

The automatic selector unit permits fast automatic filling of one or more pressure vessels on filling panels from an intermediate unit and simultaneously from the compressor. One pressure vessel always has priority, i.e. the storage unit and the compressor always fill the pressure vessel first. When this is full, the intermediate storage unit is automatically replenished by the compressor until a new empty cylinder is connected to the filling panel.

FUNCTION

Once the pressure vessel has been connected to the filling panel and the cylinder and filling valves have been opened, air flows out of the intermediate storage unit into the cylinder. This takes place until pressure equalisation, for example between the diving cylinders and intermediate storage unit. The compressor switches on automatically and fills the cylinder first up to the maximum filling pressure. Once this is full, the compressor automatically replenishes the intermediate storage unit, and switches off automatically when the maximum filling pressure is reached.

The automatic selector unit performs 3 important functions:

- › Pre-filling of the cylinders from the storage bottle battery by overflow until pressure equilibrium
- › Filling of the diving cylinders up to the filling pressure directly from the compressor
- › Refilling the storage bottle battery to the max. storage pressure

The automatic unit consists of a pressure retention and check valve with integrated pressure sensor that switches off the compressor unit on or off in each case. When this automatic unit is used, a cascade filling connection is superfluous. The two pressure gauges are used for checking the preliminary and back pressure. The pressure sensor is used for controlling the compressors.

AUTOMATIC SELECTOR UNIT WITH PRESSURE SWITCH OR PRESSURE SENSOR FOR B-CONTROL.

TECHNICAL DATA

- › **Transition:** DN4
- › **Operating pressure:** PN350 bar
- › **Adjustment range:** Pressure relief valve / pressure retention valve: 100 - 350 bar
- › **Dimensions:** W x H x D: 400 x 250 x 150 mm

CONNECTIONS:

- › **Input:** G^{3/8}, connection for either Ø 8 mm or Ø 10 mm pipe
- › **Output:** Ø 8 or Ø 10 mm

SCOPE OF DELIVERY

- › The unit is completely piped up and ready to connect

Designation	Order number
Automatic selector unit with pressure sensor N25421, up to 350 bar, B-Control and pressure retention valve 80751	82116-KD
Automatic selector unit with pressure switch N4526, up to 350 bar, BC2/BC6 or MV (without B-CONTROL/COMP-TRONIC) and pressure retention valve 80751	82116-S02
Automatic selector unit with pressure sensor N25421, up to 350 bar, B-CONTROL and pressure retention valve 80751, stainless steel	82116-S03
Automatic selector unit with B-CONTROL pressure sensor, up to 420 bar	82117
Automatic selector unit with pressure switch, up to 350 bar and Tescom pressure retention valve	062796
Automatic selector unit with pressure sensor N19999 for COMP-TRONIC, up to 350 bar and Tescom pressure retention valve	072862
Automatic selector unit with 2 COMP-TRONIC pressure sensors, up to 350 bar	074875

PRESSURE GAUGE

The pressure gauges operate according to the Bourdon tube principle. They are hermetically sealed, filled with glycerine and have internal pressure compensation. We recommend these pressure gauges if there are high dynamic loads, pressure peaks, vibrations and pulsations. The glycerine fill considerably reduces the effects of loads. High display accuracy, stable pointer position and a long service life are the result. The hermetically sealed design prevents condensation from forming on the inside, as well as the penetration of aggressive atmosphere that can lead to corrosion damage. The sturdy stainless steel housing made of CrNi steel has a pressure release opening that is closed with a plastic cap.

TECHNICAL DATA

- › **Pressure range:** from -1 to 600 bar depending on version
- › **Pressure display:** in bar and psi
- › **Accuracy class:** 1.6
- › **Medium:** Air, gases and oils
- › **Temperature range:** from -25 to +60°C
- › **Pressure connection:** R 1/4"
- › **Safety version:** DIN 16007
- › **For front panel mounting (with front ring) required hole diameter:** 63mm Ø

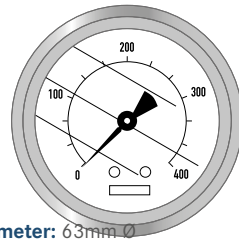

MATERIAL

- › **Connection:** Brass
- › **Housing:** Cr Ni steel
- › **Front ring:** Cr Ni steel
- › **Measuring device:** Cu alloy

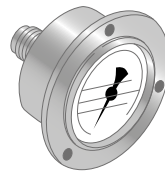

Connection
at rear



Connection
at bottom

The pressure gauges can be used for air, methane, noble gases as well as for suitable oils. **INFO for pressure gauge selection!** The pressure to be measured should be in the range from 10-70% of the final scale value!

PRESSURE GAUGE SELECTION

Pressure range	Connection		Front ring	Glycerine fill	Order number
	bar	bottom			
-1 to 1.5	-	Yes	Yes	Yes	N3865
0-10	-	Yes	Yes	Yes	N16758
0-16	-	Yes	Yes	Yes	N1269
0-16	-	Yes	-	Yes	N22331
0-25	-	Yes	Yes	Yes	N1270
0-40	-	Yes	Yes	Yes	N18041
0-60	-	Yes	Yes	Yes	N15543
0-100	-	Yes	Yes	Yes	N1271
0-160	-	Yes	Yes	Yes	N1273
0-250	-	Yes	Yes	Yes	N7673
0-315	Yes	-	-	-	N1315
0-400	-	Yes	-	Yes	N22330
0-400	-	Yes	Yes	Yes	N2623
0-400	Yes	-	-	-	N4101
0-600	Yes	-	-	Yes	N16872
0-600	-	Yes	-	Yes	N17062
0-600	-	Yes	Yes	Yes	N17351

SCREWED FITTING FOR PRESSURE GAUGE

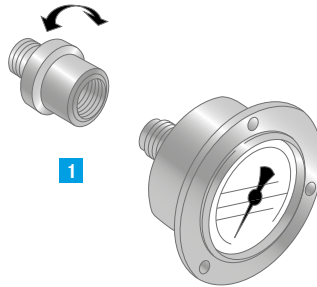

1

Designation

Screwed fitting for pressure gauge G1/4 to 6-S pipe connector

Order number

N3569

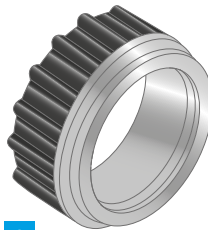

2

Designation

Plastic cap for pressure release opening

Order number

N26664-KD

2. Rubber protection cap **only for pressure gauges with connection at bottom!**

N15985

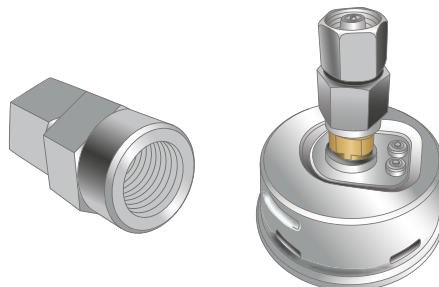

Designation

Screwed fitting for pressure gauge 6-S / G1/4

Order number

N29858

OPERATING HOURS COUNTER

OPERATING HOURS COUNTER, ELECTRIC

Operating hours counter, recommended for electrically operated compressor units.

SCOPE OF DELIVERY

› Counter with clamping bracket for front plate mounting.

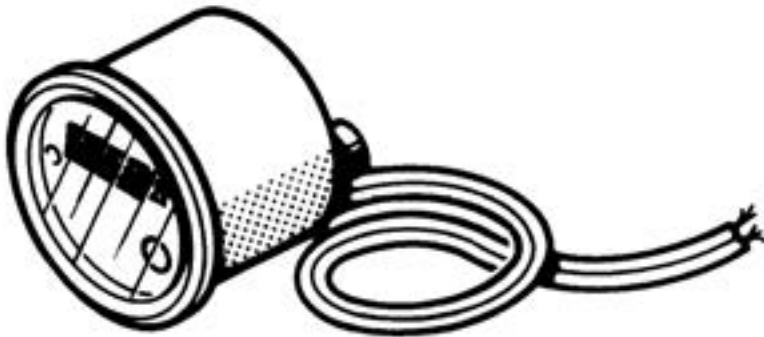

Designation	Dimensions	Order number
Operating hours counter 230 V, 60 Hz	50.2 x 25.2 mm	N21791
Operating hours counter 24 VDC	92 x 92 mm	N20785
Operating hours counter 230 V, 50 Hz	Ø 61 mm	N3263
Operating hours counter 230 V, 60 Hz	Ø 61 mm	N3264
Operating hours counter 12/24 V, direct current	Ø 60 mm	N1734
Operating hours counter 24 V, 50/60 Hz	56 x 56 mm	N23853
Operating hours counter 230 V 60 Hz	Ø 50 mm	N22338
Operating hours counter 230 V	50.2 x 25.2 mm	N21791
Operating hours counter 230 V	45 x 45 mm or Ø 50 mm	N16208
Operating hours counter 230 V	45 x 45 mm or Ø 50 mm	N16625
Operating hours counter 12 VDC	48 x 24 mm	N18345
Operating hours counter 24 V 50 Hz	52 x 52 mm	N18365



OPERATING HOURS COUNTER, MECHANICAL

Vibration counter, recommended for compressor units with petrol or diesel engines without electrical power supply as well as for explosion-proof compressor units.

Designation

Order number

Vibration counter petrol/diesel engines, 60 mm diameter

N3475

OPERATING HOURS COUNTER – CARTRIDGE MONITORING, BATTERY-OPERATED

B-TIMER: electronic operating hours counter including cartridge monitoring, recommended in the breathing air application. Suitable for compressors with petrol/diesel and electric drive.

(More information on the B-TIMER can be found on page 16)

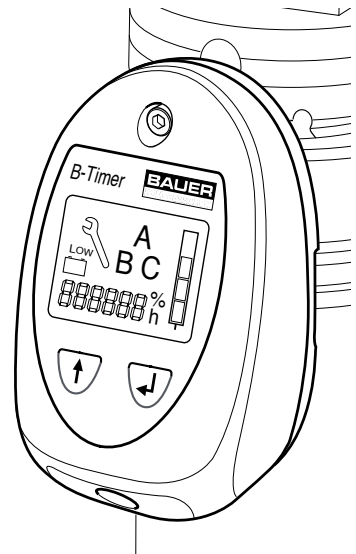

THERMOMETER

Remote temperature gauge for displaying the compression temperature of the last stage (for BAUER UTILUS models up to KAP 180). Application range on the aftercooler with a pipe \varnothing 8 mm.

TECHNICAL DATA

- › **Housing:** \varnothing 60 mm flush-mounted with clamping bracket
- › **Measuring range:** 0 - 200 °C
- › **Length of capillary tube:** 1.5 m
- › **Connection:** Thread R 1/4

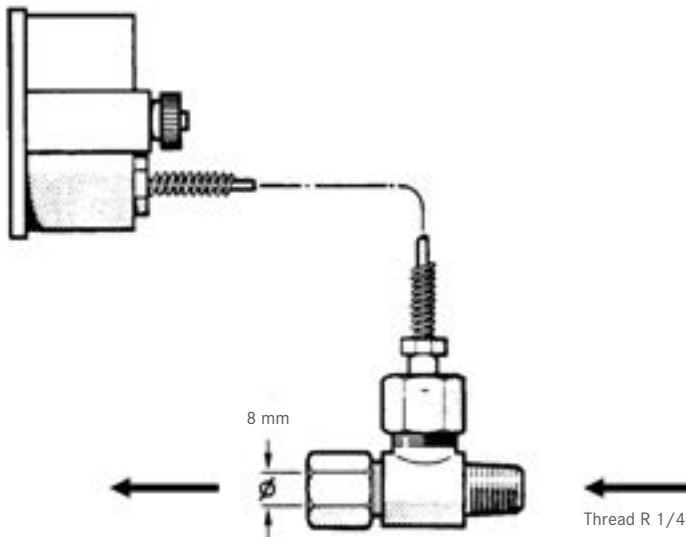

Designation

Remote temperature gauge

Order number

059125

PRESSURE MONITORING

PRESSURE SWITCHES

Pressure switches are devices for automatic pressure monitoring on compressors and pressure accumulators. When the set pressures of i.e. oil pressure. Intermediate and final pressure are reached, the electrical contact switches over.

The compact pressure switch used for typical filling operation is a piston pressure switch. It is used for monitoring the final pressure during filling (breathing air systems) in conjunction with a semi-automatic control. Switch-off pressure can be adjusted.

TECHNICAL DATA

- › **Switching frequency:** maximum 60 / min.
- › **Contiguous load:** with alternating voltage max. 250 V / 5 A with direct current voltage max. 30 V / 5 A
- › **Index of protection:** IP65
- › **Switching accuracy:** +/-3% of the setting range
- › **Temperature range:** -40 °C to +80 °C
- › **Material of the contacts:** Silver
- › **Working contact:** 1 changeover contact

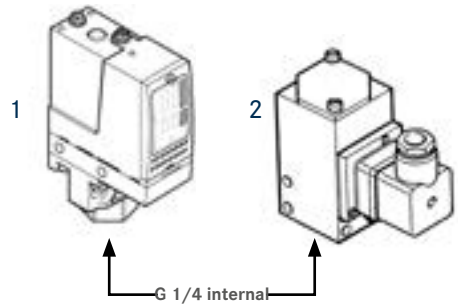

	Adjustment range		Hysteresis	Voltage	Max. permitted pressure		Order number
	bar / min.	bar / max.	bar	max. volt	continuous bar	intermittent bar	
1	7	70	4.7 to 50	500	90	160	N15014
	10	160	9.3 to 100	500	200	360	N16361
	22	300	19.4 to 200	500	375	675	N4527
	30	500	23.0 to 300	500	625	1125	N4526
2	220	350	30 fixed	250	400	400	N1010

PRESSURE TRANSDUCER

PRESSURE TRANSDUCER FOR COMP-TRONIC

Pressure transducers are used instead of pressure switches in electronic controls with analogue inputs. The sensors are adapted to our COMP-TRONIC. The measured values of the pressure transducers are shown on the display in "bar" or "psi g", and can be evaluated as operating, maintenance, advance warning or fault messages.

TECHNICAL DATA

- › **Medium:** Air, gases
- › **Material of the housing and parts in contact with the medium:** DIN17440-1.4404 (AISI 316 L)
- › **Weight:** 0.3 kg
- › **Linearity deviation (minimum value setting):** +/-0.2% FS
- › **Hysteresis and reproducibility:** + / -0.1 % FS
- › **Nominal output signal:** 1-5 VDC; 3-wire version
- › **Supply voltage:** 10-30 VDC
- › **Current consumption:** < 5 mA
- › **Connection type:** Plug DIN43650
- › **Cable version:** IP 67 – IEC 529
- › **Temperature range:** -40 °C to +85 °C
- › **EMC emission:** EN 50081-1
- › **Accuracy:** typ. +/-0.3% FS; max. +/-1% FS

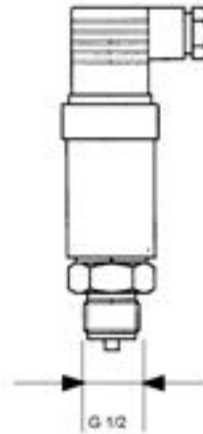

Designation	Order number
Measuring range 0 - 25 bar	N19997
Measuring range 0 - 100 bar	N19998
Measuring range 0 - 400 bar	N19999
Measuring range 0 - 600 bar	N20813
Female fitting with pipe connection 6 mm	N20176
Seal-edge ring (seal between sensor and connector)	N3081

PRESSURE TRANSDUCER FOR B-CONTROL

The following pressure transducers are available for B-CONTROL: (Output signal 4-20 mA)

TECHNICAL DATA

- › **Medium:** Air, gases
- › **Material of the housing and parts in contact with the medium:** DIN17440-1.4404 (AISI 316 L)
- › **Weight:** 0.2 kg
- › **Linearity deviation (minimum value setting):** + / -0.1 % FS
- › **Hysteresis and reproducibility:** + / -0.1 % FS
- › **Nominal output signal:** 4-20 mA
- › **Supply voltage:** 12.5-28 VDC
- › **Current consumption:** < 28 mA
- › **Connection type:** Plug IEC 947-5-2 M12x1
- › **Cable version:** IP 67 – IEC 529
- › **Temperature range:** -40 °C to +85 °C
- › **EMC emission:** EN 50081-1
- › **Accuracy:** typ. +/-0.1% FS max. +/-5% FS



Designation	Order number
Pressure transducer measuring range 0 to 10 bar	N25419
Pressure transducer measuring range 0 to 25 bar	N35655
Pressure transducer measuring range 0 to 100 bar	N25420
Pressure transducer measuring range 0 to 400 bar	N25421
Pressure transducer measuring range 0 to 600 bar	N25422
Pressure transducer measuring range -1 to +1.5 bar	N25418
Seal CU 1/4	N4051

VALVES

BLEED VALVES

These assemblies are provided for installation in the main air flow. This makes it possible to depressurise pressurised filter housings so as to allow the system to be serviced.

SCOPE OF DELIVERY

- ▶ Bleed valve complete with pressure gauge

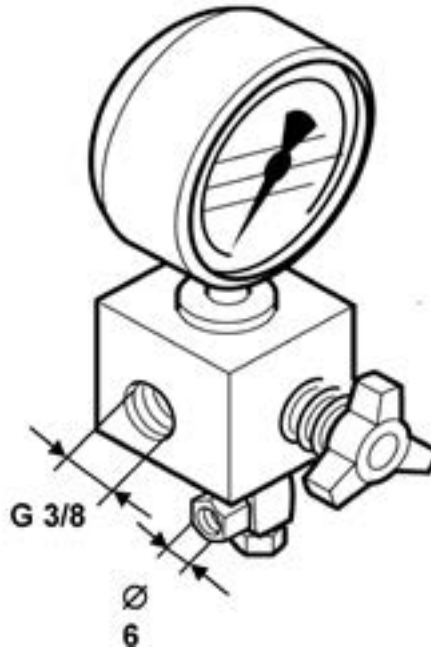

Designation	Operating pressure	Pressure gauge	Order number
	bar / max.	bar	
Bleed valve with pressure gauge	420	0 – 600	064566
Bleed valve with pressure gauge and check valve	420	0 – 600	065839

SCOPE OF DELIVERY

- ▶ Bleed valve only for bleeding, attachment to a covering

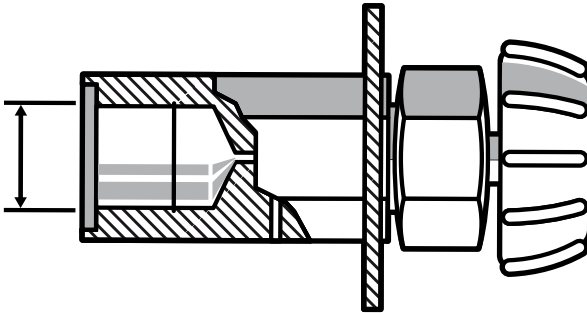

Designation	Operating pressure	Connection thread	Bleed hole	Order number
	bar / max.	max. bar	mm ϕ	
Bleed valve for covering	350	G $\frac{3}{8}$ internal	1.5	061650
Bleed valve with pressure gauge and check valve	350	G $\frac{1}{4}$ internal	1.5	060374

SAFETY VALVES, TYPE-TESTED WITH TÜV

BAUER safety valves monitor the pressure with absolute reliability – for your safety. Safety valves are used according to technical regulations to monitor pressure overshoots in pressure vessels. According to these regulations, they must be of sufficient size to prevent exceeding the permitted working overpressure by more than 10%.

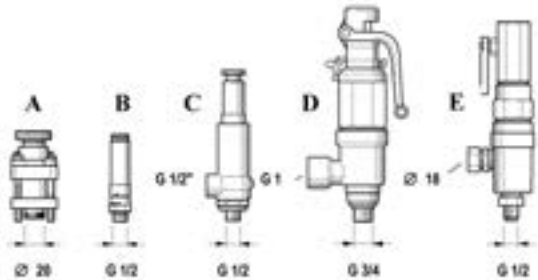

Operating pressure	Nominal size	Blow-off rate	Connection	Figure / version	CE acc. to PED	Order number + pressure specification
bar	mm	m ³ /h	on - off		DGRL 2014/68 EU	
5		75	G 1/4		CE	81801
9.9		137	G 1/4		CE	81802
100-365	3	6	G ^{3/8}	A - ventable	—	120541
100-365	5	60	20 mm Ø		CE	059410
8	10	250	G 1/2	B - ventable	CE	N19349
20	10	520	G 1/2		CE	N1671
40	8	485	G 1/2		CE	N18505
2.6 - 4.5	10	105 - 160	G 1/2 - G 1/2	C - gas-tight ventable	CE	N26256
4.6 - 7	10	160 - 233	G 1/2 - G 1/2		CE	N26257
7.1 - 11	10	233 - 348	G 1/2 - G 1/2		CE	N26258
11.1 - 17	10	348 - 527	G 1/2 - G 1/2		CE	N26259
17.1 - 25	10	527 - 762	G 1/2 - G 1/2		CE	N26254
25.1 - 35	10	762 - 1056	G 1/2 - G 1/2		CE	N26174
35.1 - 54	10	1056 - 1615	G 1/2 - G 1/2		CE	N26175
54.1 - 68	10	1615 - 2025	G 1/2 - G 1/2		CE	N26160
68.1 - 93	10	2025 - 2764	G 1/2 - G 1/2		CE	N26253
93.1 - 121	10	2764 - 3588	G 1/2 - G 1/2		CE	N26252
121.1 - 180	10	3588 - 5324	G 1/2 - G 1/2		CE	N26233
180.1 - 215	6	2760 - 3294	G 1/2 - G 1/2		CE	N27387
215.1 - 330	6	3294 - 5048	G 1/2 - G 1/2		CE	N27394
330.1 - 370	6	5042 - 5779	G 1/2 - G 1/2		CE	N27846
4.1 - 5.8	15	395 - 537	G 3/4 - G 1		D - gas-tight ventable	CE
20.5 - 31	15	1723 - 2563	G 3/4 - G 1	CE		N26262
31.1 - 44	15	2563 - 3620	G 3/4 - G 1	CE		N26263
135.1 - 170	15	10,998 - 13,728	G 3/4 - G 1	CE		N26264
175.1 - 200	15	13,700 - 16,100	G 3/4 - G 1	CE		N26265
200.1 - 230	15	7780 - 8940	G 3/4 - G 1	CE		N26820
230.1 - 250	15	8940 - 9720	G 3/4 - G 1	CE		N26821
245 - 315	6	1200 - 1550	G 1/2	E - gas-tight ventable	CE	N17067
190 - 245	6	950 - 1150	G 1/2		CE	N17068
315 - 390	6	1550 - 1900	G 1/2		CE	N16778
390 - 525	6	1900 - 2200	G 1/2		CE	N17066





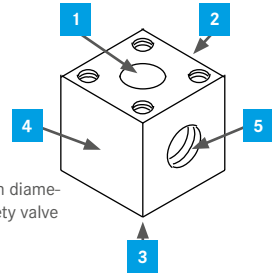

When ordering, please specify the pressure setting and state whether TÜV acceptance is required.

SAFETY VALVE ADAPTER

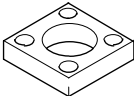

20 mm is the lower pin diameter of the 059410 safety valve

Safety valve adapter	1	2	3	4	5	Top thread or hole	Bottom thread or hole	Note	Accessories	Order number
63325  300bar	20 mm ∅	1/4 Int. thread	1/4 Int. thread	●	●	2xM8 diagonal	2xM6 diagonal	only for 059410 SIV	M8x60 socket head screw for 059410 O-ring	N19555 N4882
67798  500bar	20 mm ∅	1/4" internal thread	●	1/4" internal thread	●	4xM8	4xM8			
68520  420bar	20 mm ∅	3/8 int. thread	●	3/8 int. thread	●	4xM8	4xM8			
72341  360bar	20 mm ∅	3/8 int. thread	3/8 int. thread	3/8 int. thread	1/4	2xM8 diagonal	●	only for 059410 SIV	Socket head screw M8x60 for 059410 O-ring	N19555 N4882
128182  500bar	20 mm ∅	1/4" internal thread	1/4" internal thread	1/4" internal thread	●	4xM8	4xM8			
75282 NIRO!  365bar	20 mm ∅	●	3/8" external thread	●	●	2xM8 diagonal	●	only for 059410 SIV NIRO !	Socket head screw M8x60 for 059410 O-ring	N19555 N4882
64013  350bar	3/8 int. thread	●	20 mm ∅	●	●	2x8.5∅ diagonal	●	For SIV with 3/8" exter- nal thread to 20 mm ∅	Socket head screw M8x25 O-ring	N19548 N4882
064038-KD Like 64013, only complete with O-ring N4882 and 2 socket head screws N19548	3/8 int. thread	●	20 mm ∅	●	●	2x8.5∅ diagonal	●	For SIV with 3/8" exter- nal thread to 20 mm ∅	Socket head screw M8x25 O-ring	N19548 N4882
90237  350bar	●	●	20 mm ∅	●	●	2x8.5∅ diagonal	●	Blind flange	Socket head screw M8x25 O-ring	N19548 N4882
090318 As for 90237, but complete with O-ring N4882 and 2 socket head screws N19548	●	●	20 mm ∅	●	●	2x8.5∅ diagonal	●	Blind flange	Socket head screw M8x25 O-ring	N19548 N4882

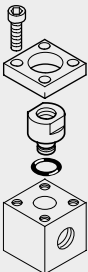
Adapter 20mmØ	1		3	Hole	Examples	Note	Accesso- ries	Order number
67797 	1/2 Int. thread	●	20 mm Ø	● ● ●			O-ring	N4882
350bar 64118 	3/4 Int. thread	●	20 mm Ø	● ● ●		Mainly used for Leser valves	O-ring	N4882
350bar 64119 		●	●	● ● 4x8.5Ø	●		Socket head screw M8x25	N19548
N4882 							O-ring, also for 059410 safety valve	
N19548 							Socket screw M8x25	
Installation 						Important! Always use 4 screws for assembly.		

Attention! All images are for illustrative purposes only and may differ from the original!

BALL VALVES

SHUT-OFF BALL VALVES

Ball valves are characterised by their favourable, linear flow, and permit high flow rates. The seals are also suitable for oil-free and dry air. The switching handle makes the OPEN-CLOSED position visible and is easy to operate. The switching handle is supplied.

Temperature of the medium: -20 °C to +100 °C.

If shut-off valves have developed a leakage over time, they can be repaired using the repair kits described below.

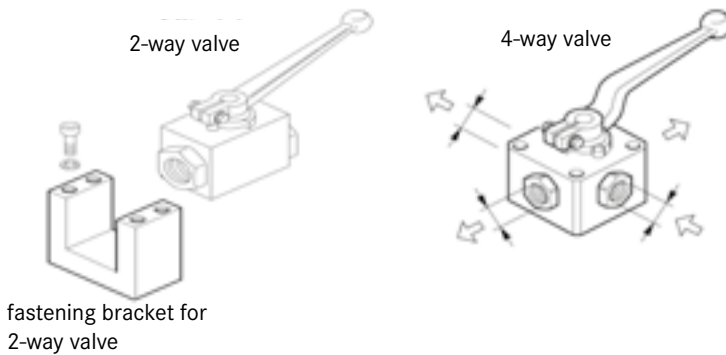

Designation	Thread	DN	L	B	Repair kits	Order number	
Block ball valve		mm	bar	mm	mm		
2-way valve	G 3/8	10	350			N26450	
2-way valve	G 1/4	6	350			N26449	
4-way valve with X-hole	G 1/8	3	400	55	45	N6452	N3352
3-way valve with L-hole	G 1/4	6	400	82	70	N6485	N3045
4-way valve with X-hole	G 1/4	6	400	70	55	N6486	55241
2-way valve	G 1/4	6	500	50	25		N26462
2-way valve	G 3/8	10	500	60	30		N26463
2-way valve	G 1/2	12	500	75	35		N4027
Shut-off ball valve for oil drain	G 1/2	122					N25638
Optional							
spare part sealing screw for N25638							N29199
Fastening bracket for two-way valve N26462 (G1/4) 500 bar							87476
Fastening bracket for two-way valve N26449 (G1/4) 350 bar							12546

PRESSURE MAINTAINING VALVES

The pressure maintaining valves provide for correct and operationally safe function of the air and gas compressors as well as the air and gas purification systems.

Furthermore, these reduce the dynamic pressure load on the final oil/water separator and filter pressure vessels.

We recommend pressure retention valves should be checked every 500 operation hours or once a year to ensure they are functioning correctly. Every 1000 operating hours or every 2 years, renew the internal components (e.g. seals, sleeves, O-rings and pistons).

Please also refer to our maintenance kits.

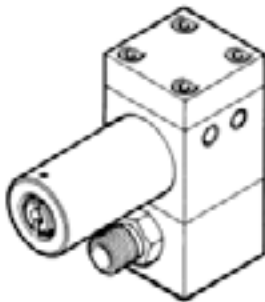

400 bar

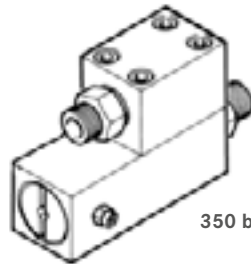

350 bar

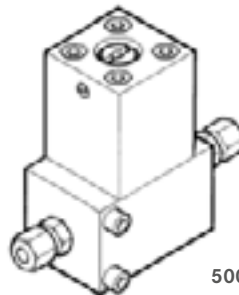

500 bar

PRESSURE MAINTAINING VALVES

Operating pressure	Setting range	Outlet pipe	Remarks	Order number
bar / max.	bar	mm		
150	100	8 mm		062516
150	100	8 mm		071043-KD
350	160	G ¼	for P21	78538
350	240	8 mm		063838-KD
350	240	8 mm	AMAG	065469-KD
350	240	10 mm	Japan	068385
350	240	8 mm		075330
350	240	8 mm	only oxygen	075413-KD
350	240	8 mm	AMAG	090062-KD
350	240	8 mm	P-filter	80751
350	240	8 mm	CNG	81401
350	240	¼ NPT	NPT vers.	057351
350	240	G ¼	Diving	80760
350	240		Japan	80804
350	240	8 mm		80815
400	270	10 mm		056705
400	270	12 mm		060510
500	340	6 mm	PURE AIR	071386
500	340	8 mm		068275

PRESSURE REDUCERS

BAUER pressure reducers achieve excellent control precision in high-pressure technology for medium and relatively high flow rates, because of the valve design with pressure relief.

The regulators are characterised by a lag-free response, they are largely insensitive to intake pressure fluctuations, leak-tight on zero flow rate, have a high wear resistance and thus guarantee a long service life. All other possible changes to the material such as corrosion are avoided. In this way, you maintain the precision and function without impairment. The control is not dependent on temperature, because spring-loaded pressure reducers are used. An integrated overflow valve allows the secondary pressure to be reduced in the closed pressure system.

Pressure reducers are used for reducing the pressure of the medium from a higher to a lower level, as a result of which a corresponding flow rate is set based on the particular valve structure; furthermore, they reduce the pilot pressure from a monitoring unit for controlling a dome pressure reducer (secondary pressure).

DESIGN:

The housing and spring housing are produced from Dural or aluminium bronze; the valve spindle and valve seat are stainless steel. A non-slip dial is used for infinitely variable pressure setting.

NOTE:

To safeguard the secondary pressure, we recommend a BAUER safety valve should be installed in the pressure line without fail; refer to the "Safety valves" chapter for the product description and order numbers. The pressure setting must be to the nominal pressure of the consumer, e.g. the distributor station. To avoid damage by particles, we recommend fitting a suitable particulate filter $\leq 20 \mu\text{m}$ on the inlet side e.g. order number 060490.

EXPLANATION:

Primary pressure is the inlet pressure before the pressure reducer. Secondary pressure is the outlet pressure after the pressure reducer. This information is necessary to identify the correct article in your order.

PRESSURE REDUCERS

Pressure reducer for installation in lines and control panels. High control accuracy. When ordering, please specify the required primary and secondary pressure as well as the order number. Generally, it is essential to fit a particulate filter at the inlet of the pressure reducer. Recommended filter: Particulate filter N3635.

TECHNICAL DATA

- › **Medium:** Air, non-aggressive gases (N₂ + noble gases)
- › **Design:** Housings and spring housings are made of Dural or aluminium bronze produced, the piston rings from aluminium bronze. The valve spindle and valve seat are from stainless steel. A grippy dial is used for infinitely variable pressure setting.
- › **Temperature range of the medium:** -10 °C to +100 °C
- › **Pressure range:** Primary pressure: 250 or 420 bar
Secondary pressure: 0.1 to 280 bar
- › **Connection:** G 3/8 internal primary and secondary sides
- › **Dimensions:** Height: 200 mm, Ø: 80 mm

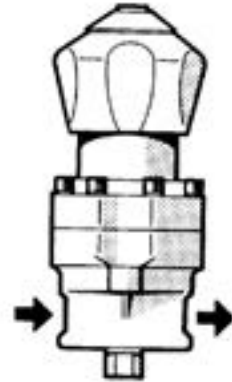

Connection	Primary pressure bar / max.	Secondary pressure bar	Air flow rate* m ³ /min	Repair kits	Order number
G 3/8	250	0.1 – 50	7.4	On request	N4795
G 3/8	250	0.1 – 105	14.5	On request	N4794
G 3/8	420	0.1 – 11	1.6	On request	N4796
G 3/8	420	0.1 – 50	7	N 6487	N4797
G 3/8	420	0.5 – 140	16	On request	N4798
G 3/8	420	28 – 280	32	N6292	N3967
Optional					
Particulate filter					N17325
Pressure reducer for breathing air systems					N21826

* At max. primary pressure and max. secondary pressure, in relation to +20 °C and 1 bar absolute

PRESSURE REDUCER AIR, GASES

Pressure reducer for installation in lines and control panels. High control accuracy. When ordering, please specify the required primary and secondary pressure as well as the order number.

Recommended filter: We recommend the BAUER particulate filter N17325; with its filter fineness of 20 µm, it reliably traps particles and thus guarantees the long service life of the pressure reducer.

TECHNICAL DATA

- › **Medium:** Air, gases
- › **Design:** Housing and spring housing made of aluminium alloy. Pistons made of aluminium bronze, membrane of metal.
- › **Pressure release valve, valve seat:** Soft plastic (Peek). The version with a dial is recommended for infinitely variable pressure setting with sealed secondary pressure, available at extra cost.
- › **Temperature range of the medium:** -20 °C to +70 °C
- › **Pressure range:** Primary pressure: 465 bar Secondary pressure: 1.5 to 410 bar
- › **Connection:** G 3/8 internal primary and secondary sides
- › **Dimensions:** Height: 200 mm, Ø: 70 mm, Ø: 90 mm (handwheel)

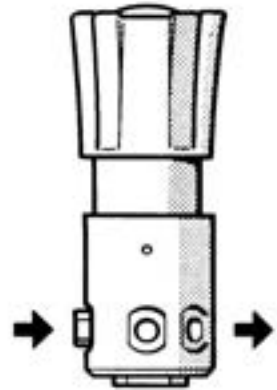

Primary pressure	Secondary pressure	Air flow rate*	Repair kits	Order number
bar / max.	bar	m ³ /min		
465	1.5 - 52	approx. 7.5	N24264	N15859
465	34 - 240	approx. 6.1	N21795	N15860
465	207 - 410	approx. 4.4	N24265	N15861

* At 420 bar primary pressure and max. secondary pressure in relation to +20 °C and 1 bar absolute

PISTON PRESSURE REDUCER AIR

The valve seats are protected by a 20 µ particulate filter. A non-slip dial for infinitely variable pressure setting. A mounting is required for installation in control panels. When ordering, please specify the required primary and secondary pressure as well as the order number.

TECHNICAL DATA

- › **Medium:** Air
- › **Design:** Housing made of anodised aluminium, valve seat of bronze and stainless steel. Seals made of Viton.
- › **Temperature range of the medium:** -10 °C to +100 °C
- › **Pressure range:** Primary pressure: max. 420 bar
- › **Secondary pressure:** 0.1 to 350 bar
- › **Air flow rate:** 155Nm³/h, 420 bar
- › **Connection:** ¼ NPT primary and secondary sides
- › **Dimensions:** Height: 140 mm, Ø: 57 mm

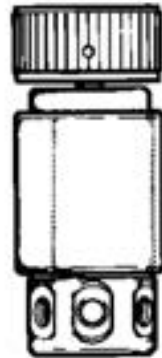

Designation	Air flow rate*	Order number
	m ³ /hrs.	
Pressure reducers	155	N21826
Mounting for pressure reducer		74039
Repair kit for pressure reducer		N23086

Optional: Designation	Number of	Pipe diameter	Connection thread	Order number
Straight male connector	2	6 S	¼NPT	N20264
Union nut	2	6 S		N3610
Cutting ring	2	6 S		N3663
Straight male connector	2	8 S	¼ NPT	N20266
Union nut	2	8 S		N3608
Cutting ring	2	8 S		N3609
Screw plug	2		¼ NPT	N4472

MEMBRANE PRESSURE REDUCER

Pressure reducer for installation in lines and control panels. High control accuracy and non-slip dial for infinitely variable pressure setting. Recommended filter: Particulate filter N3635. When ordering, please specify the required primary and secondary pressure as well as the order number.

TECHNICAL DATA

- › **Medium:** Air, gases
- › **Design:** Housing made of Dural aluminium,
Spring housing of aluminium,
Valve seat and cone made of stainless steel with
Teflon coating, membrane of Dural / Perbunan
- › **Temperature range of the medium:** -10 °C to +100 °C
- › **Connection:** G 3/4 internal primary and secondary sides
- › **Dimensions:** Height: 200 mm, Ø: 83 mm
- › **Weight:** approx. 1.8 kg

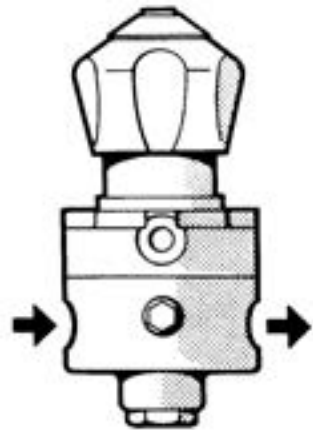

Primary pressure	Secondary pressure	Air flow rate*	Repair kits	Order number
bar / max.	bar	m ³ /min		
25	0.1 – 1	0.75	N29705	N22531
42	0.1 – 1		N26001	N23296 (CNG)
42	0.3 – 5	3.5		N17612
42	0.5 – 11	6.0		On request
42	0.5 – 25	14.0		N21940
42	10 – 31	11.0		N21106
60	0.1 – 1	1.0	N6291	N3632

DOME PRESSURE REDUCERS

Direct-action dome pressure reducer for installation in lines. Soft-skin seal – tight closing at zero flow rate. Recommended filter: N4817 for PN420. We recommend the BAUER particulate filter N4817; with its filter fineness of 20 µm, it reliably traps particles and thus guarantees the long service life of the pressure reducer.

When ordering, please specify the required primary and secondary pressure as well as the order number.

TECHNICAL DATA

- › **Medium:** Air, gases
- › **Design:** Housing and dome made of forged aluminium bronze. Valve spindle and valve seat made of stainless steel
- › **Ambient temperature:** +5 °C to +45 °C
- › **Temperature range of the medium:** -20 °C to +100 °C, in special version down to -50 °C

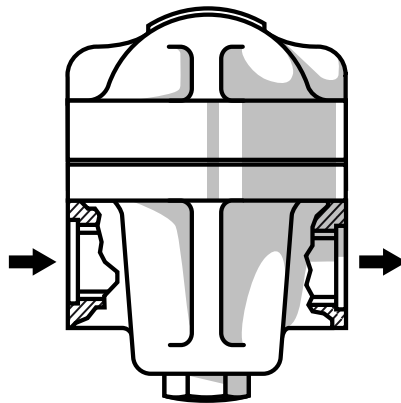

Primary pressure	Secondary pressure	Air flow rate	Height	Diameter	Screw-in thread	Repair kits	Order number
bar / max.	bar	m ³ /min	mm	mm	inch		
420	0.1 – 280	160	160	120	G 1	N6294	N25191

1 At max. secondary pressure in relation to +20 °C and 1 bar absolute

HIGH-PRESSURE REDUCING UNIT

Pressure reduction on outlet side

For wall mounting

For stationary applications

Dimensions with ball valves: approx. 580 mm x 250 mm x 224 mm (WxHxD)

SCOPE OF DELIVERY (COMPLETELY MOUNTED ON WALL PANEL)

- › 2x ball valves
- › 1x pressure gauge on inlet side
- › 1x pressure gauge on outlet side
- › 1x pressure reducer
- › 1x safety valve (setting value depends on required outlet pressure!)
- › 2x bleed valve
- › 1x panel for wall mounting

These high-pressure reducing stations cannot be used for intake pressure reduction because of the technical configuration! The outlet pressure setting should only be adjusted rarely! (Not intended for continuous adjustment).

Permitted for the following media

Air, nitrogen, helium, argon.

AIR **N2** **HE** **AR**

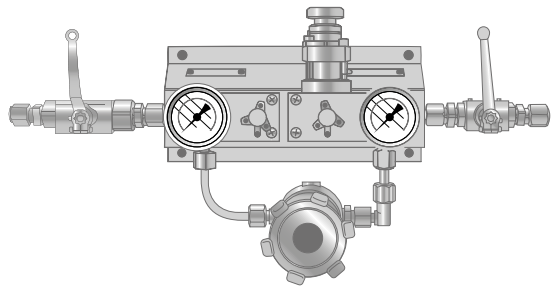

Input pressure	Output pressure	Comment	Order number
bar / max.	from / to		
365	5-40		077838-V001
365	41-100		077838-V002
365	101-220		077838-V003
365	221-350		077838-V004
365	41-100	Stainless steel design	077838-V005
365	41-230	Higher flow volume	077838-V006

When ordering, you must specify the required maximum outlet pressure!

PRECISION STAINLESS STEEL PIPE

Stainless steel pipes offer the best protection against corrosion in the piping system.

TECHNICAL DATA

- › **External diameter:** from 6 – 42 mm
- › **Internal diameter:** from 3 – 38 mm
- › **Lengths:** 3 m standard, 6 m on request
- › **Wall thickness tolerance:** Class T1 acc. to DIN 2462
- › **Material:** 1.4541
- › **Available lengths:** Standard 3 m
6 m on request (minimum order 15 pipes)

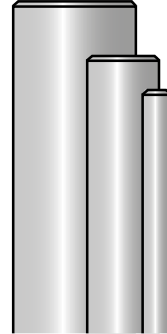

IMPORTANT INFORMATION

The pressure information in the table below (page 95) has been calculated acc. to DIN 2413 application range I for 20 °C room temperature. At higher temperatures, only a reduced pressure loading is permitted, which can be calculated by means of a calculation factor.

The guidance value for the flow speed in pipes is 6 – 15 m/s
Material coefficient: K = 235 N/mm² safety factor: S 1.5

Example with 50 °C pipe temperature and 200 bar pressure:

Factor = 0.945, which means: 200 bar x 0.945 = **189 bar max. pressure**

Example with 100 °C pipe temperature and 200 bar pressure:

Factor = 0.885, which means: 200 bar x 0.885 = **177 bar max. pressure**

See DIN 17440 for the exact calculation

PRECISION STAINLESS STEEL PIPES

mm/bar Ø/max.	120	135	140	165	170	180	205	220	297	345	385	425	450	540
6x1.0											N3616			
6x1.5														N3617
8x1.0									N3618					
8x1.5												N3619		
8x2.0														N18356
10x1.0							N3620							
10x1.5										N4699				
10x2.0													N17973	
12x1.0							N15098							
12x1.5									N3621					
12x2.0											N16242			
12x3.0														N17118
15x1.0				N15130										
15x1.5							N3622							
16x2.0										N15504				
18x1.0			N15934											
18x1.5							N15467							
20x2.5									N20942					
20x3.0											N23672			
22x1.5					N15466									
22x2.0								N16255						
28x1.5		N15836												
28x2.0						N18278								
42x2.0	N17878													

Max. pressure values at 20 °C

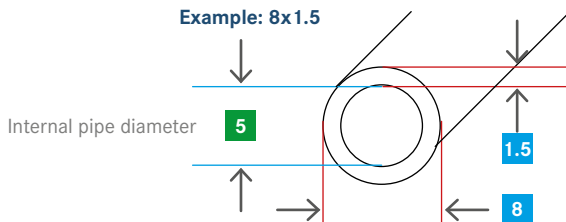

Please note the correction calculation of the pressure based on the temperature.
See (Important information!) on page 90.

PIPE CLAMPS

These parts are fastening elements for the piping to be routed.
The following versions can be used.

Recommended clamp spacing for attachment to an immobile base:

Designation	Clamp spacing
Pipe Ø 6-12 mm	0.9 m
Pipe Ø 15-22 mm	1.2 m

Recommended clamp spacing for attachment to a vibrating base:

Designation	Clamp spacing
Pipe Ø 6-12 mm	0.45 m
Pipe Ø 15-22 mm	0.6 m

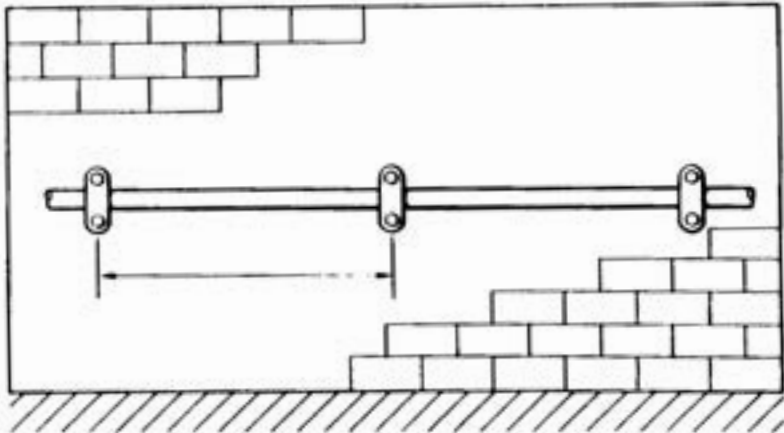

Clamp spacing

PLASTIC CLAMPS

For attaching individual pipes. Recommended for below 60 °C operating temperature.

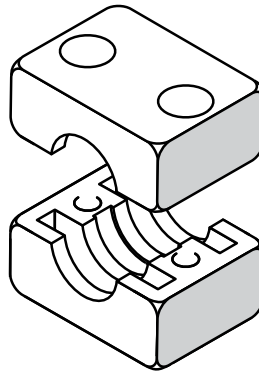

Designation	Order number
Plastic clamp for pipe Ø 6 mm	N27858
Plastic clamp for pipe Ø 8 mm	N17270
Plastic clamp for pipe Ø 10 mm	N17271
Plastic clamp for pipe Ø 12 mm	N17272
Plastic clamp for pipe Ø 15 mm	N15075
Plastic clamp for pipe Ø 16 mm	N17577
Plastic clamp for pipe Ø 18 mm	N17273
Plastic clamp for pipe Ø 20 mm	N17274
Plastic clamp for pipe Ø 22 mm	N17275
Plastic clamp for pipe Ø 28 mm	N23679
Mounting rail / C-rail	N23614
Rail nut (M6)	N23613
Screw M6 x 30 mm for N17269/N17270/N17271/N17272	N19536
Screw M6 x 35 mm for N15075/N17577/N17273	N19537
Screw M6 x 40 mm for N17274/N17275	N19538
Screw M6 x 45 mm for N23679	N19539

1 You require two clamps in each case

ALUMINIUM CLAMPS

For attaching 2 pipes:

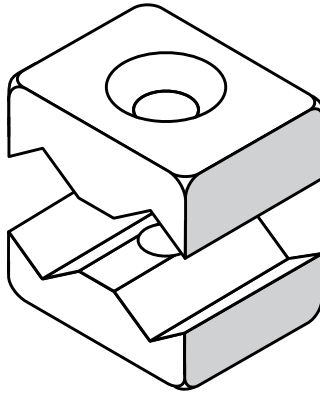

Designation

Order number¹

Pipe external Ø 6-10 mm

13967

For attaching 3 pipes:

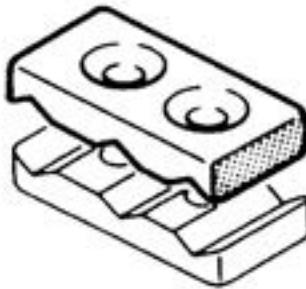

Designation

Order number¹

Pipe external Ø 6 - 10 mm

55579

¹ You require two clamps in each case

ALUMINIUM CLAMPS

For attaching 4 pipes:

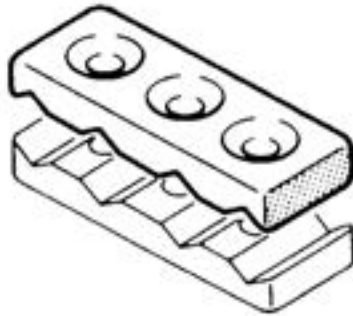

Designation

Order number¹

Pipe external Ø 6 - 10 mm

55589

Dowel for wall fastening:

Designation

Order number

Dowel Ø 6, L 30

N24430

Dowel Ø 8, L 40

N24654

Dowel Ø 10, L 50

N3766

Dowel Ø 12, L 60

N24339

Dowel Ø 14, L 75

N17056

HOSES

ATTENTION: MAXIMUM OPERATING PRESSURE

Hoses are available for various pressure ranges, and also with different connectors.

Please note that the maximum permitted operating pressure depends on the individual part with the lowest pressure range.

Please comply with the specified application data!

Temperature range: -10 °C / 14 °F to +50 °C / 122 °F.

Ambient temperature: +60 °C / 140 °F up to +80 °C / 176 °F permitted for short periods.

Flow speed: max. 10 m/s. For guidance values, see the tables section.

CAUTION

Constant pressure and continuous load cycles in the hoses reduce the service life considerably. This application cannot be recommended. Please note that the application and test regulations are subject to the various regulations in the country where the hoses are used

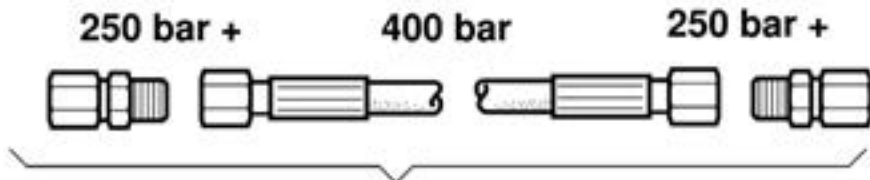

Permitted maximum pressure: 250 bar max.

HOSE BREAK PROTECTION

Filling hoses are often exposed to harsh conditions which can significantly increase their durability, such as: Excessively high or low temperatures, moisture, salty air, contamination of all kinds (e.g.: substances containing oil or solvents)

Incorrect or inadvertent handling such as: kinking, stretching, incorrect handling of the screwed fittings. Incorrect handling of breathing air cylinders. (e.g.: by allowing unsecured cylinders to fall over)

Everyone must be aware of the consequences of such a hose break. The sudden emergence of air and the whipping movements of the hose can cause very severe injuries! Danger of fatal injury!

Our robust hose break protection can be fitted in a matter of moments and offers additional safety.

The 5 mm thick steel cable makes it flexible, and allows it to be attached to the existing hose easily. For protection and better securing, the hose clamp is additionally provided with a protective rubber pad.

The system has been optimised for our current UNIMAM filling hoses, but is also suitable for other hose types with the same diameters.

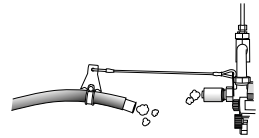
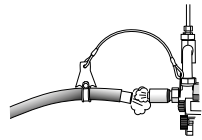
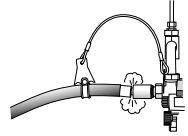

TECHNICAL DATA

- ▶ **Length of wire rope:** 300 mm
- ▶ **Eyelet diameter:** 12 mm
- ▶ **For hose diameters from:** 10-13 mm
- ▶ **Spanner size for mounting the clamp:** 10 mm

SCOPE OF DELIVERY FOR PROTECTING ONE HOSE

Two wire ropes with mounting accessories.
Order number: 178115

Pre-assembled full-protection safety pin	Spare part number
EXISTING HOSE IS REPLACED	
LENGTH: 1 METRE	N2817-S07
LENGTH: 1.50 METRE	N3351-S07



Safety kit	Spare part number
VOLUME: 2X N39198 WIRE CABLE, 2X N39199 FIXING CLAMP	
RETROFIT OPTION USING THE EXISTING HOSE	178115



FILLING HOSES

BAUER KOMPRESSOREN high-pressure connecting hoses are suitable for breathing air, flexible, have a hose protector and handle on the pressure gauge side, as well as being equipped with fittings made of stainless steel. All hoses and fittings are 100% pressure-tested, are subjected to a 20,000 cycle test and are certified accordingly. BAUER KOMPRESSOREN filling hoses have a very high permitted temperature range. Optionally available with pressure test certificate 10204-3.1B.

TECHNICAL DATA

- › **External diameter:** approx. 10 mm
- › **Exterior coating:** perforated
- › **Suitable for:** Air, helium, nitrogen, noble gases, UNIMAM hoses expressly suitable for breathing air
- › **Resistant to ambient influences:** salty air, seawater, sunshine and fuels such as petrol, diesel oil
- › **Material:** Fluoropolymer (FEP)
- › **Temperature:** -40 °C to +100 °C
- › **Length:** see table
- › **Colour:** black
- › **Permitted operating pressure:** 425 bar at 45 °C

M16x1.5

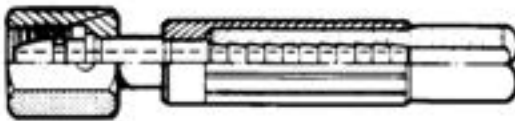

UNIMAM connector

FILLING HOSES WITH UNIMAM CONNECTOR SWIVELING WHEN DEPRESSURIZED

Length	Operating pressure	Connection thread	DN	Order number
mm	bar / max.		mm	
500	425	M 16 x 1.5	5	N4216
800	425	M 16 x 1.5	5	N41090
1000	425	M 16 x 1.5	5	N2817
1500	425	M 16 x 1.5	5	N3351
2000	425	M 16 x 1.5	5	N2818
3000	425	M 16 x 1.5	5	N2819
5000	425	M 16 x 1.5	5	N18397
6000	425	M 16 x 1.5	5	N3657
9000	425	M 16 x 1.5	5	N20724
10,000	425	M 16 x 1.5	5	N24614
12,000	425	M 16 x 1.5	5	N21707
15,000	425	M 16 x 1.5	5	N22730
20,000	425	M 16 x 1.5	5	N23084
25,000	425	M 16 x 1.5	5	N23146
30,000	425	M 16 x 1.5	5	N23147
50,000	425	M 16 x 1.5	5	N23396
O-ring for UNIMAM			6L-6S	N20755
O-ring for UNIMAM			8L-8S	N20756
O-ring for UNIMAM	M 16 x 1.5			N16632

HIGH PRESSURE HOSES

Length	Operating pressure	Connection thread	DN	Union nut	Order number
mm	bar / max.		mm		
320	315	M 12 x 1.5	4	6L/6L	N20743
500	315	M 12 x 1.5	4	6L/6L	N3253
800	315	M 12 x 1.5	4	6L/6L	N20744
320	315	M 14 x 1.5; M 12 x 1.5	4	6S/6L	N20745
500	315	M 14 x 1.5; M 12 x 1.5	4	6S/6L	N18319
800	315	M 14 x 1.5; M 12 x 1.5	4	6S/6L	N18321
630	425	M 16 x 1.5	5		N30443
320	450	M 14 x 1.5	4	6S/6S	N18323
500	450	M 14 x 1.5	4	6S/6S	N18320
800	450	M 14 x 1.5	4	6S/6S	N18322
100	450	M 14 x 1.5	4	6S/6S	N4822
500	450	M 16 x 1.5	6	8S/8S	N3864
500			6	8L/8L	N19347

CUTTING RING SCREWED FITTING

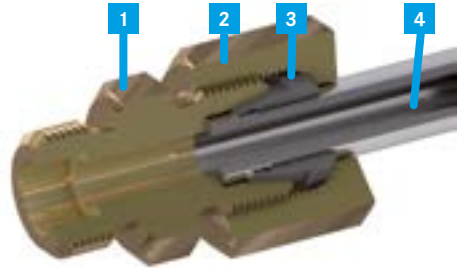

- 1 Screwed fitting
- 2 Union nut
- 3 Cutting ring
- 4 Pipe

THE APPLICATION RANGE FOR THE CUTTING RING SCREWED FITTINGS THAT WE USE:

- › **Pipe diameter:** from 6 to 42mm
- › **Pipe material:** steel, aluminium, stainless steel
- › **Pressure range:** to 630 bar
- › **Medium:** Air, gases, oils, suitable liquids
- › **DIN:** always conform to the latest regulations

QUALITY FEATURES

We exclusively use screwed fittings from leading manufacturers. Screwed fittings, nuts and cutting rings are supplied as standard in a steel version with phosphate coating, to protect against corrosion. Stainless steel version at extra cost. Please specify in your order!

INSTALLATION

Saw off the pipe at right angles, then slightly deburr the cut end and clean it. Push the union nut and cutting ring onto the pipe, insert into the cone of the screwed fitting, push up against the pipe and then tighten the union nut. Check the cutting of the cut edge following installation.

IMPORTANT!

Some of the pressures can be in excess of 600 bar, so incorrect installation represents a risk of fatal injury! Please comply with the precise installation instructions in our workshop manual! This also contains additional helpful tips and information about compressor technology.

Order number

OVERVIEW OF THE MOST COMMON PIPE FITTINGS



STRAIGHT MALE CONNECTOR (GES)



ANGLE MALE CONNECTOR (WES)

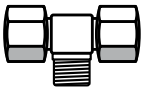

T-MALE CONNECTOR (TES)

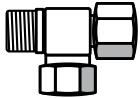

L-MALE CONNECTOR (LES)



STRAIGHT PIPE CONNECTOR (GS)

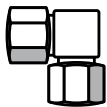

ANGLE PIPE CONNECTOR (WS)

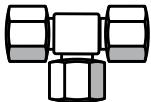

T-PIPE CONNECTOR (TS)

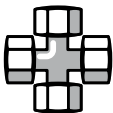

CROSS PIPE CONNECTOR (KV)



STRAIGHT BULKHEAD CONNECTOR (GSS)

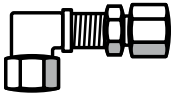

ANGLE BULKHEAD CONNECTOR (WSS)



WELD-ON PIPE CONNECTOR (ASS)



WELD-IN BULKHEAD CONNECTOR (ESS)

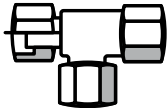

ADJUSTABLE L-PIPE CONNECTOR (ELS)

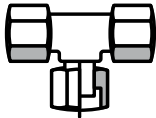

ADJUSTABLE T-PIPE CONNECTOR (ETS)

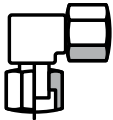

ADJUSTABLE ANGLE PIPE CONNECTOR (EWS)



ADJUSTABLE STRAIGHT PIPE CONNECTOR (EGES)



REDUCTION PIPE CONNECTOR (RED)

STRAIGHT PIPE CONNECTORS (GS) NORMAL VERSION

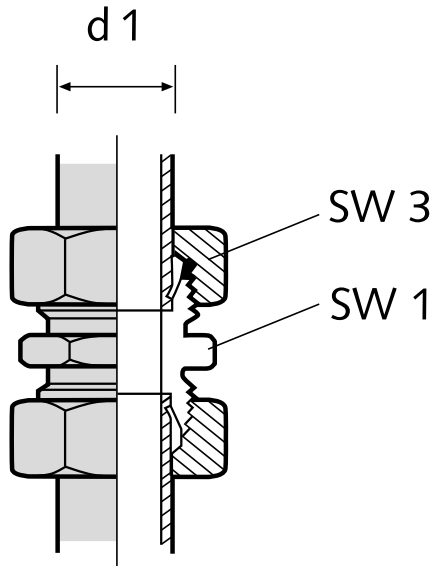

PN	Pipe external Ø d1	SW1	SW3	Order number
bar	mm	mm	mm	
100	28	41	41	N22487
160	18	27	32	N20312
160	22	32	36	N20313
250	6	12	14	N20157
250	8	14	17	N20379
250	10	17	19	N20309
250	12	19	22	N20310
250	15	24	27	N20311
400	16	27	30	N20347
400	20	32	36	N20348
630	6	14	17	N20168
630	8	17	19	N20208
630	10	19	22	N20190
630	12	22	24	N20101

STRAIGHT PIPE CONNECTORS (GS) STAINLESS STEEL VERSION

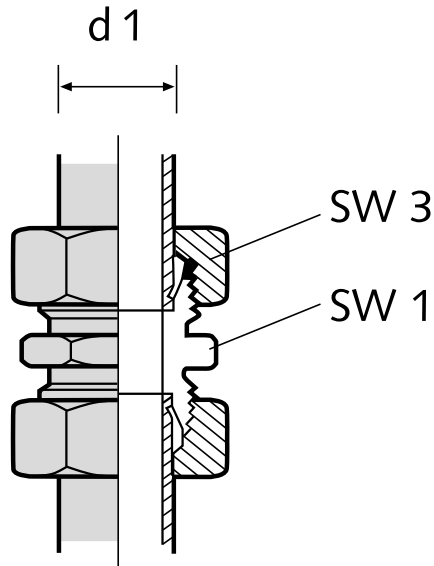

PN	Pipe external \varnothing d1	SW1	SW3	Order number
bar	mm	mm	mm	
40	20	32	36	N24424
100	28	41	41	N23640
160	18	27	32	N20433
160	22	32	36	N20426
250	6	12	14	N20442
250	10	17	19	N20584
250	12	19	22	N20140
250	15	24	27	N20436
630	6	14	17	N20499
630	8	17	19	N20585
630	10	19	22	N23394
630	12	22	24	N23387

STRAIGHT MALE CONNECTORS (GES)

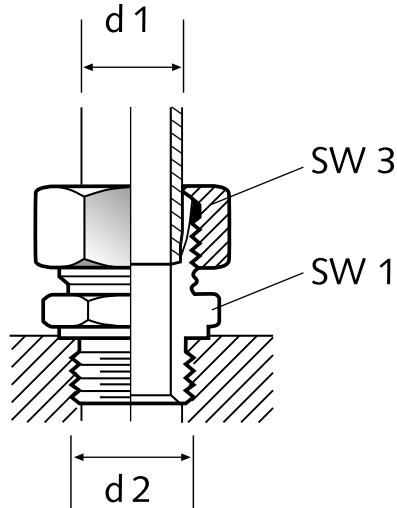

PN	Pipe external $\varnothing d_1$	d_2	SW 1	SW 3	Order number for screwed fitting without seal
bar	mm		mm	mm	
100	28	G 1	41	41	N20308
160	18	G 1/2	27	32	N20013
160	22	G 3/4	32	36	N20230
250	6	G 1/8	19	14	N20002
250	8	G 1/4	19	17	N20014
250	10	G 1/4	19	19	N20188
250	12	G 3/8	22	22	N20009
250	15	G 1/2	27	27	N20231
400	16	G 1/2	27	30	N18244
400	20	G 3/4	32	36	N20351
630	6	G 1/4	19	19	N20195
630	8	G 1/4	19	19	N20209
630	8	G 3/8	19	19	N20551
630	10	G 3/8	22	22	N20229
630	12	G 3/8	22	24	N20011
Order numbers for screwed fittings with integrated soft seal					
160	18	G 1/2	27	32	N20075
400	20	G 3/4	32	36	N20032

STRAIGHT BULKHEAD CONNECTORS (GSV)

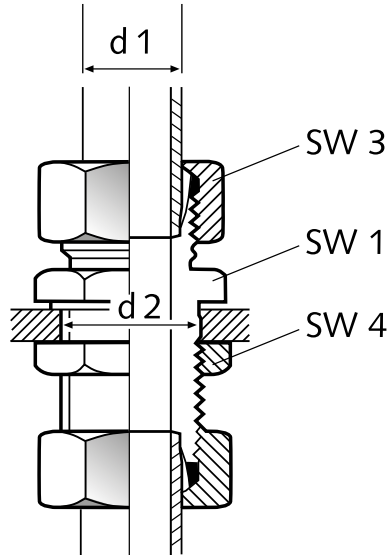

PN	Pipe external $\varnothing d_1$	d_4	SW1	SW3	SW4	Order number
bar	mm	mm	mm	mm	mm	
160	18	28	32	32	36	N15537
160	22	32	36	36	41	N4582
250	6	14	17	14	17	N3995
250	8	16	19	17	19	N3172
250	10	18	22	19	22	N4659
250	12	20	24	22	24	N4338
250	15	24	27	27	30	N4619
400	16	26	32	30	32	N15505
400	20	32	41	36	41	N15854
630	6	16	19	17	19	N3083
630	8	18	22	19	22	N3300
630	10	20	24	22	24	N4168
630	12	22	27	24	27	N4683

ANGLE BULKHEAD CONNECTORS (WSV)

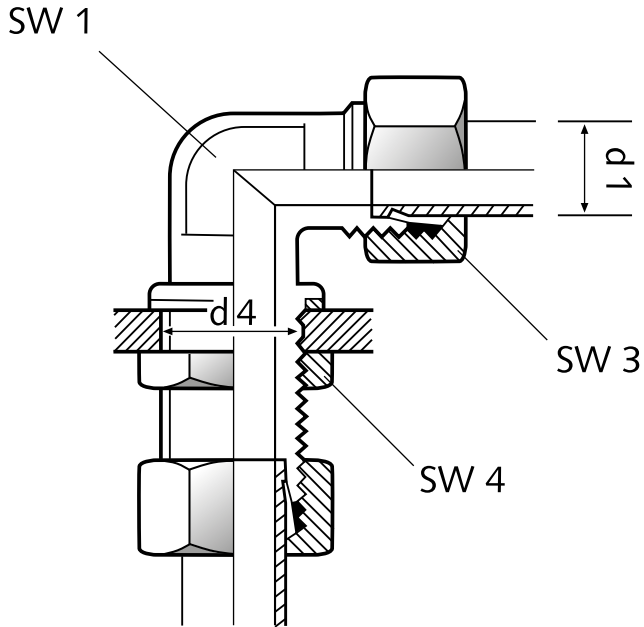

PN	Pipe external $\varnothing d_1$	d_4	SW 1	SW 3	SW 4	Order number
bar	mm	mm	mm	mm	mm	
160	18	28	24	32	36	N18147
160	22	32	27	36	41	N18155
250	8	16	12	17	19	N2787
250	10	18	14	19	22	N15202
250	12	20	17	22	24	N16271
250	15	24	19	27	30	N3171
400	16	26	24	30	32	N18148
400	20	32	27	36	41	N4932
630	6	16	12	17	19	N4477
630	8	18	14	19	22	N4322
630	10	20	17	22	24	N4658
630	12	22	17	24	27	N4684

ANGLE MALE CONNECTORS (WEV)

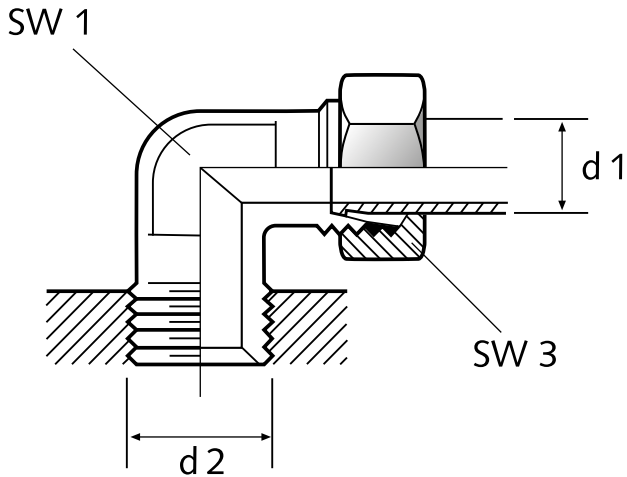

PN	Pipe external Ø d1	d4	SW1	SW3	Order number
bar	mm		mm	mm	
160	18	G ½	24	32	N 661
160	22	G ¾	27	36	N 7403
250	6	G ⅛	12	14	N 1057
250	8	G ¼	14	17	N 1536
250	10	G ⅜	17	19	N 1065
250	12	G ½	19	22	N 2917
250	15	G ⅝	19	27	N 1856
400	16	G ½	24	30	N 8011
400	20	G ¾	27	36	N 8026
630	6	G ¼	14	17	N 1048
630	8	G ¼	17	19	N 3044
630	10	G ⅜	19	22	N 7727
630	12	G ½	22	24	N 4681

ADJUSTABLE ANGLE SCREW CONNECTOR (EWS)

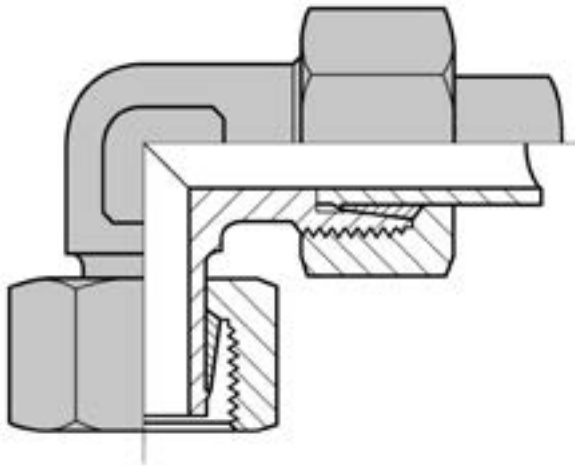

PN	Pipe external Ø d1	Series	Order number
bar	mm		
250	6	L	N20186
250	8	L	N20152
250	10	L	N20160
250	12	L	N20200
250	15	L	N20257
400	16	S	N20225
400	20	S	N20031
630	6	S	N20187
630	8	S	83220
630	10	S	N20154
630	12	S	N20282

T-CONNECTORS (TV)

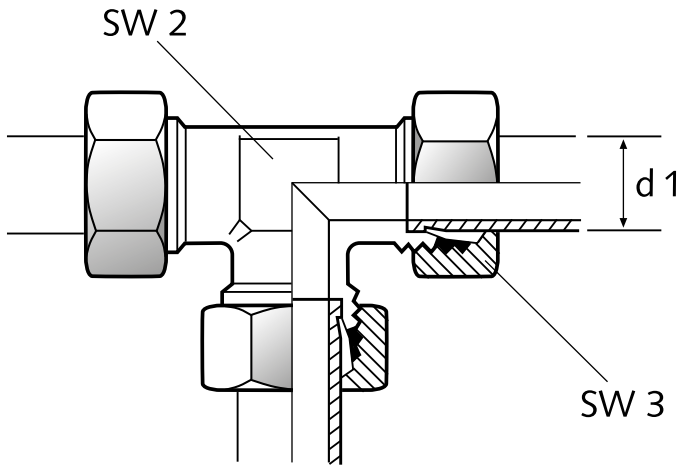

PN	Pipe external Ø d1	SW2	SW3	Order number
bar	mm	mm	mm	
100	28	36	41	N 7513
160	18	24	32	N7428
160	22	27	36	N7429
250	6	12	14	N3134
250	8	14	17	N3025
250	10	17	19	N3010
250	12	19	22	N7426
250	15	19	27	N7427
400	16	24	30	N 8022
400	20	27	36	N18149
630	6	14	17	N3968
630	8	17	19	N3710
630	10	19	22	N4922
630	12	22	24	N17924

ADJUSTABLE T-CONNECTORS (ETS)

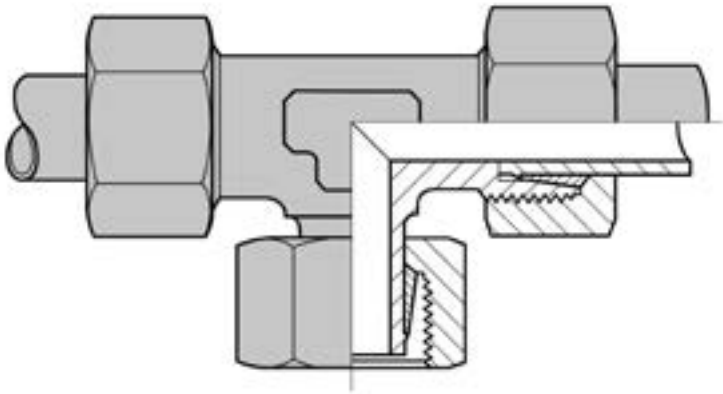

PN	Pipe external Ø d1	Series	Order number
bar	mm		
250	6	L	N20238
250	8	L	N20155
250	10	L	N20068
250	12	L	N20051
250	15	L	N20029
400	16	S	N20419
400	20	S	N20259
630	6	S	N20019
630	8	S	N20206
630	10	S	N20064
630	12	S	N20057

ADJUSTABLE L-CONNECTORS (ELS)

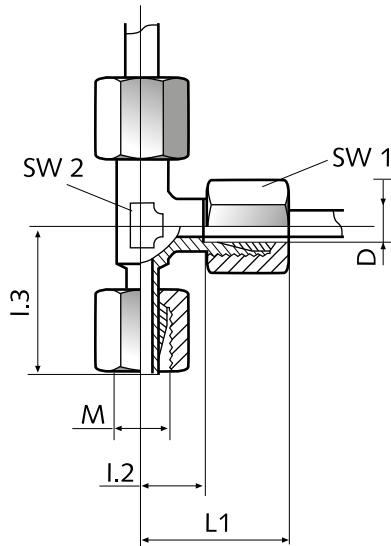

PN	Pipe external Ø d1	Series	Order number
bar	mm		
250	6	L	N20167
250	8	L	N20219
250	10	L	N20213
250	12	L	N20289
250	15	L	N20052
400	16	S	N20422
400	20	S	N23503
630	6	S	N20185
630	8	S	N20175
630	10	S	N20276
630	12	S	N20055

CUTTING RINGS

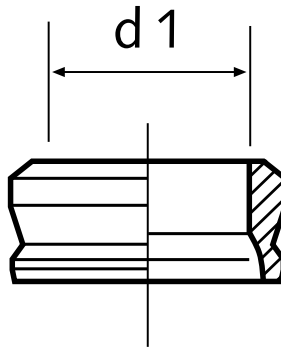

PN	Pipe external $\varnothing d1$	Series	Order number
bar	mm		
100	28	L	N7445
160	18	L	N7443
160	22	L	N7444
250	6	L	N3663
250	8	L	N3609
250	10	L	N4011
250	12	L	N7441
250	15	L	N3614
400	16	S	N4009
400	20	S	N18154
630	6	S	N3663
630	8	S	N3609
630	10	S	N4011
630	12	S	N7441

LOCK NUTS

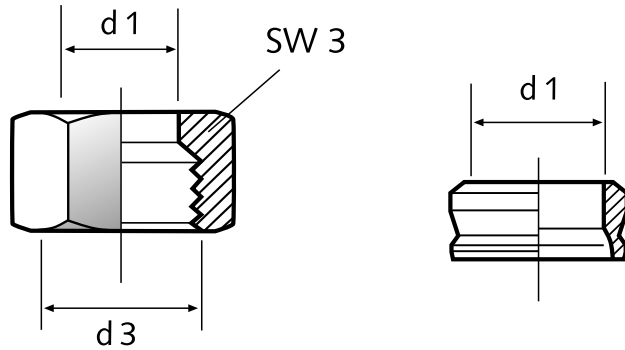

PN	Pipe external Ø d1	d3	SW3	Series	Order number
bar	mm		mm		
100	28	M 36 x 2	41	L	N7437
160	18	M 26 x 1.5	32	L	N7435
160	22	M 30 x 2	36	L	N7436
250	6	M 12 x 1.5	14	L	N7430
250	8	M 14 x 1.5	17	L	N1049
250	10	M 16 x 1.5	19	L	N7432
250	12	M 18 x 1.5	22	L	N7433
250	15	M 22 x 1.5	27	L	N3613
400	16	M 24 x 1.5	30	S	N4008
400	20	M 30 x 2	36	S	N18153
630	6	M 14 x 1.5	17	S	N3610
630	8	M 16 x 1.5	19	S	N3608
630	10	M 18 x 1.5	22	S	N4010
630	12	M 20 x 1.5	24	S	N15599

SEALING PLUGS (VS)

PN	Pipe external Ø d1	Ø d1	Series	Order number
bar	mm	mm		
630	6		L/S	N4530
630	8		L/S	N16309
630	10		L/S	N4831
630	12		L/S	N15175

STRAIGHT MALE CONNECTORS (GEV)

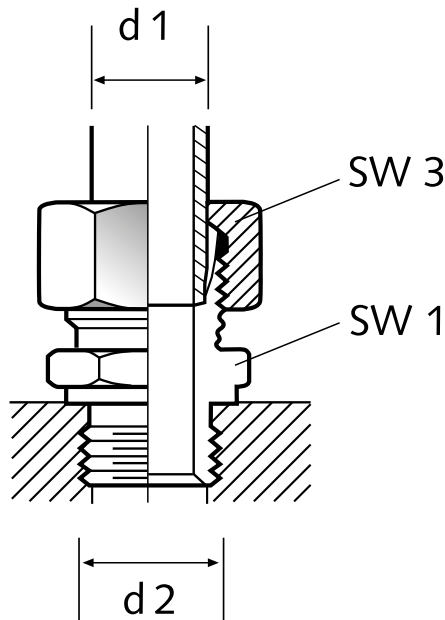

PN	Pipe external Ø d1	d2	SW1	SW3	Order number
bar	mm		mm	mm	
250	6	G 1/8	14	14	N1051
250	8	R 1/4	14	17	N1063
250	10	R 1/4	17	19	N2166
250	12	R 3/8	19	22	N1443
250	15	R 1/2	24	27	N1509
630	6	R 1/4	19	17	N 902
630	8	R 1/4	19	19	N2466
630	10	R 3/8	22	22	N3983
630	12	R 1/2	27	24	N4022

STRAIGHT MALE CONNECTORS (GES)

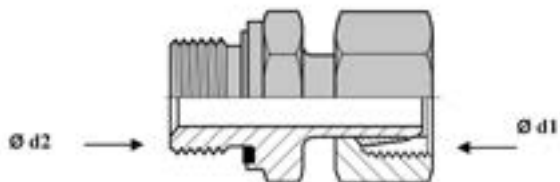

PN	Pipe external Ø d1	Ø d1	Series	Order number
bar	mm	mm		
250	8	G ¼	L	N32332
250	10	G ¼	L	N15128
250	12	G ¾	L	N32331
400	16	G ½	S	N32353
400	20	G ¾	S	N32356
630	6	G ¼	S	N32335
630	8	G ¼	S	N32301
630	10	G ¾	S	N32321
630	12	G ¾	S	N32316

REDUCTION ADAPTERS (RED)

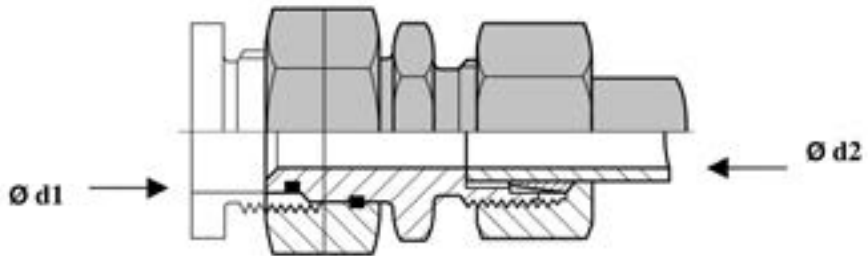

PN	Pipe external $\varnothing d1$	Pipe external $\varnothing d2$	Series	Order number
bar	mm	mm		
250	8	6	L	N20234
250	10	8	L	N20067
250	12	8	L	N20112
250	12	10	L	N20396
400	20	16	S	N23118
400	16	12	S	N20071
630	8	6	S	N20184
630	10	8	S	N20069
630	12	8	S	N20286
630	12	10	S	N20244

ANGLE SCREW CONNECTORS (WV)

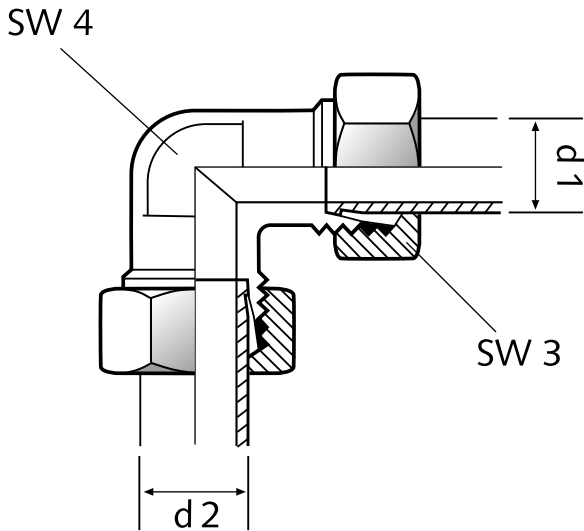

PN	Pipe external $\varnothing d_1$	SW4	SW3	Order number
bar	mm	mm	mm	
160	18	24	32	N17646
160	22	27	36	N4843
250	6	12	14	N7405
250	8	14	17	N18643
250	10	17	19	N18635
250	12	19	22	N18150
250	15	19	27	N 9227
400	16	24	30	N15511
400	20	27	36	N18152
630	6	14	17	N3012
630	8	17	19	N3946
630	10	19	22	N 7728
630	12	22	24	N18151

L-MALE CONNECTORS (LEV)

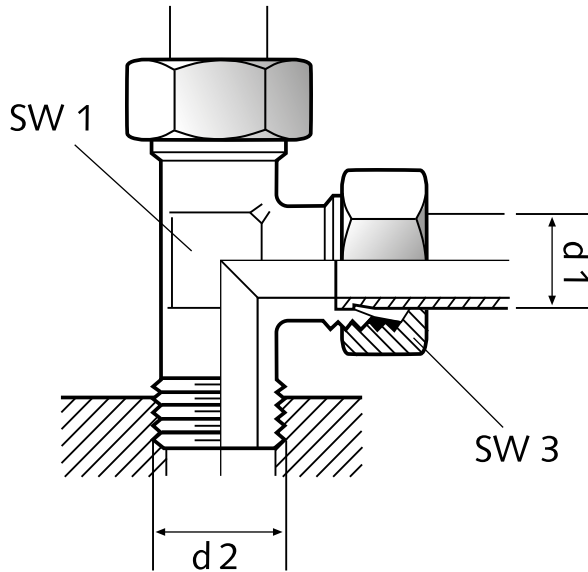

PN	Pipe external $\varnothing d_1$	d_2	SW 1	SW 3	Order number
bar	mm		mm	mm	
160	18	G ½	24	32	N7415
160	22	G ¾	27	36	N15015
250	6	G ¼	12	14	N7410
250	8	G ¼	14	17	N2902
250	10	G ¼	17	19	N7412
250	12	G ⅜	19	22	N7413
250	15	G ½	19	27	N7414
400	16	G ½	24	30	N4023
400	20	G ¾	27	36	N18156
630	6	G ¼	14	17	N2903
630	8	G ¼	17	19	N3069
630	10	G ⅜	19	22	N3142
630	12	G ⅜	22	24	N3985

T-MALE CONNECTORS (TEV)

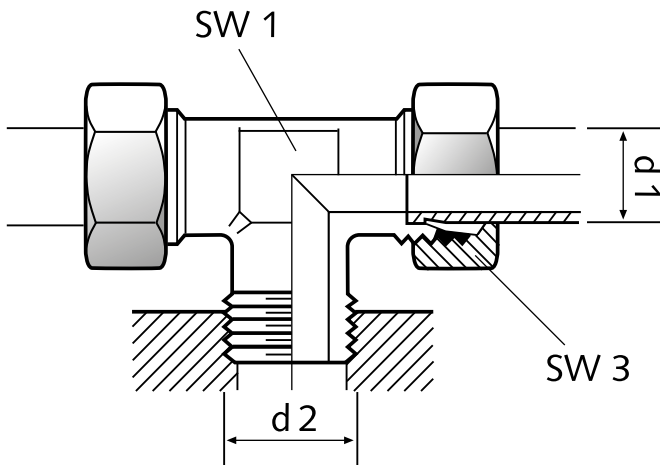

PN	Pipe external Ø d1	d2	SW1	SW3	Order number
bar	mm		mm	mm	
160	18	G ½	24	32	N18564
160	22	G ¾	27	36	N7422
250	6	G ⅛	12	14	N1106
250	8	G ¼	14	17	N1062
250	10	G ⅜	17	19	N1064
250	12	G ½	19	22	N3580
250	15	G ¾	19	27	N7420
400	16	G ½	24	30	N 8012
400	20	G ¾	27	36	N18157
630	6	G ¼	14	17	N2157
630	8	G ¼	17	19	N3068
630	10	G ⅜	19	22	N3984
630	12	G ½	22	24	N17945

CIRCUIT BREAKERS / FI PROTECTION SWITCH

TECHNICAL DATA CIRCUIT BREAKERS:

- › **Amperes:** from 1.0 to 35
- › **Volts:** from 230 to 690
- › **Pole number:**
 - 1pole
 - 1pole with N
 - 3pole
 - 3pole with N

TECHNICAL DATA FI-PROTECTION SWITCHES

- › **Ampere:** 16 to 63
- › **Triggering mA:** 30
- › **Volt:** 230 to 440
- › **Pole number:**

1Pole with N
3pole with N

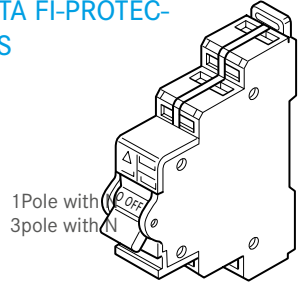

Type	Characteristics	Ampere	Volt	Order number
1-pol.	C	1	230	N24800
1-pol.	C	2	230	N24120
1-pol.	C	3	230	N24790
1-pol.	B	6	230	N20921
1-pol.	B	10	230	N25036
1-pol.	B	13	230	N27615
1-pol.	B	16	230	N26702
1-pol.+N	K	1.6	690	N24077
1-pol.+N	C	2	230	N27028
1-pol.+N	B	6	690	N25528
1-pol.+N	B	10	230	N27027
1-pol.+N	B	16	230	N27029
3-pole	K	2	690	N26351
3-pole	K	6	440	N26628
3-pole	B	16	690	N26294
3-pole	K	20	690	N24161
3-pole	K	25	690	N24075
3-pol.	K	32	400	N26781
3-pol.	K	35	690	N25437
3-pol.+N	B	16	440	N27030
FI 1-pol+N	-	16/30mA	230	N25037
FI 3-pol+N	-	25/30mA	440	N25577
FI 3-pol+N	-	63/30mA	440	N24799

PHASE SEQUENCE MONITORING

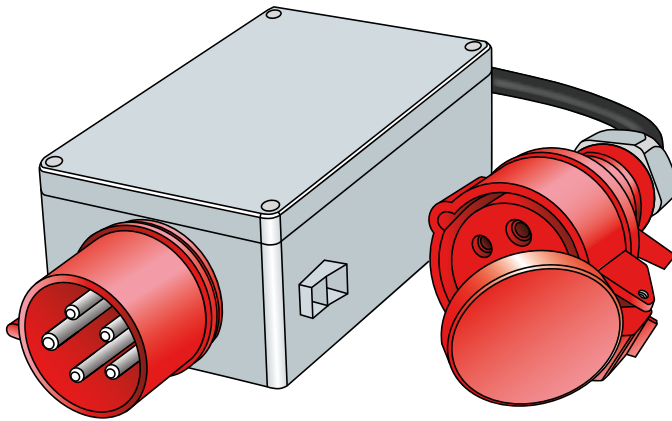

SPECIAL FEATURES

- › Optimum protection before startup in incorrect direction of rotation
- › Start interlock with missing phase on the network
- › Effective protection for persons and machinery
- › Cost-effective as supplied in full

TECHNICAL DATA

- › **Input voltage:** 400V / 50Hz
- › **Total load:** 16A or 7.5kW

Designation

Phase sequence monitoring

Order number

N44807

KA A – RETROFITTING OF JUNIOR II & OCEANUS

BASIC PACKAGE "PETROL VERSION"

- › Automatic drain
- › KAA retrofit kit
- › Pressure switch
- › Piping
- › Rectifier set

Important: Kit excludes motor

NECESSARY INFORMATION

- › Old motor incl. light coil?
- › Compressor with or without switch-over device?

BASIC PACKAGE "ELECTRIC VERSION"

- › Automatic drain
- › KAA retrofit kit
- › Pressure switch
- › Piping
- › Electric box

NECESSARY INFORMATION

- › Compressor in two or three-phase operation?
- › Compressor with or without switch-over device?

Type	ET number type
JUNIOR II-B	168088-JII-F01
JUNIOR II-W	168088-JII-F01
JUNIOR II-E	168088-JII-F01
OCEANUS-B	168089-OCE-F01
OCEANUS-W	168089-OCE-F01
OCEANUS-E	168089-OCE-F01

JUNIOR II CONVERSION KITS

Designation	Order number
Conversion kit to JUNIOR II with petrol drive	79191-JII-B
Scope of delivery	
Petrol engine 4.2 kW	
Motor accessories consisting of V-belt N15426, V-belt pulley 62114, screws	077236
Intake telescope	077323
Conversion kit to JUNIOR II with electric drive, voltage specifications on order	79191-JII-E
Scope of delivery	
Three-phase motor 2.2 kW	N3388
Motor accessories consisting of V-belt N15426, V-belt pulley 62114, screws	077236
Motor protection switch	077956
Connection cable	077240
Conversion kit to JUNIOR II with AC drive 230 V / 50-60 Hz	79191-JII-W
Scope of delivery	
Electric motor 230 V, motor protection switch and connection cable with plug	N19108
Motor accessories consisting of V-belt N24960, V-belt pulley N15001 or 56880, screws	077237
Optional and not included in the kit:	
Motor 110 V / 50 Hz / 2.2 kW	N19111
Motor 110 V / 60 Hz / 2.2 kW	N19112
Motor 230 V / 60 Hz / 2.2 kW	N19110
Auxiliary switch	N18426

If converting to petrol drive, the appropriate filter cartridge with CO converter is supplied.
Please specify the existing filter system in your order. (e.g. P21 or P31)

OCEANUS CONVERSION KITS

Designation	Order number
Conversion kit to OCEANUS with petrol drive	79191-OCE-B
Scope of delivery	
Petrol motor 5.1 kW	
Motor accessories consisting of V-belt N15748, centrifugal clutch N26326 and screws	78699
Intake filter with intake telescope	077323
Conversion kit to OCEANUS with electric drive, voltage specifications on order	79191-OCE-E
Scope of delivery	
Three-phase motor 3.0 kW	
Motor accessories consisting of V-belt N15725 or N15426, V-belt pulley N19248 or N25590 and screws	78614
Optional:	
Motor protection switch 3 kW / 50 Hz / 400 V incl. 5 m connection cable	78628
Motor protection switch 3 kW / 220 V incl. 5 m connection cable	077956-V003
Motor protection switch 3 kW / 60Hz / 400 V incl. 5 m connection cable	077956-V006
Auxiliary switch	N18426
Conversion kit to OCEANUS with AC drive 230 V / 50-60 Hz	79191-OCE-W
Scope of delivery	
Electric motor 230 V, motor protection switch and connection cable with plug	N25633
Motor accessories consisting of V-belt N15725, V-belt pulley N19248, screws	078614

If converting to petrol drive, the appropriate filter cartridge with CO converter is supplied.
Please specify the existing filter system in your order. (e.g. P21 or P31)

MOTOR SPARE PART NUMBERS FOR COMPACT LINE

Designation	Order number
Petrol engine JUNIOR II / PE100 / OCEANUS (Subaru)	
Spark plug	N37934
Air filter element	N40404
Petrol engine MARINER320 (Subaru)	
Spark plug	N37934
Air filter element "Dual"	N37836
Electric motor JUNIOR II alternating voltage & 50HZ	
Operating capacitor	N36497
Start capacitor	N27170
On and motor protection switches	N23671
Electric motor OCEANUS alternating voltage & 50/60HZ	
Operating capacitor	N39293
Start capacitor	N39294
On and motor protection switches	N36580

RETROFIT KITS FOR AUTOMATIC CONDENSATE DRAIN

Designation	Order number
CAPITANO 140 P21	122400
CAPITANO 140 P31	122638
MARINER 320 P31	122500
MARINER 200 P21	122682
MARINER 200 P31	122683
MARINER 250 P21	122681
MARINER 250 P31	122675

OPERATING PRESSURE CONVERSION KITS

Designation	Order number
Conversion kit from 225 bar to 330 bar	074051
Scope of delivery	
Switch-over device	073796-KD
Safety valve 330 bar	059410-330
Filling hose	N2817
Filling valve 330 bar	071344
Conversion kit from 330 bar to 225 bar	074052
Scope of delivery	
Switch-over device	073796-KD
Safety valve 225 bar	059410-225
Filling hose	N2817
Filling valve 225 bar	071343

Remark: for P21 only; Not possible for PE 100

SUPER SILENT RETROFIT KITS

Designation	Order number
Super Silent V5 + PE-VE	78116-V003-RAL 9006
Super Silent MV6	180292
Super Silent V6	180293

TROLLEY

Our JUNIOR II, OCEANUS and PE100 compressors can be equipped with a trolley for easier transport.

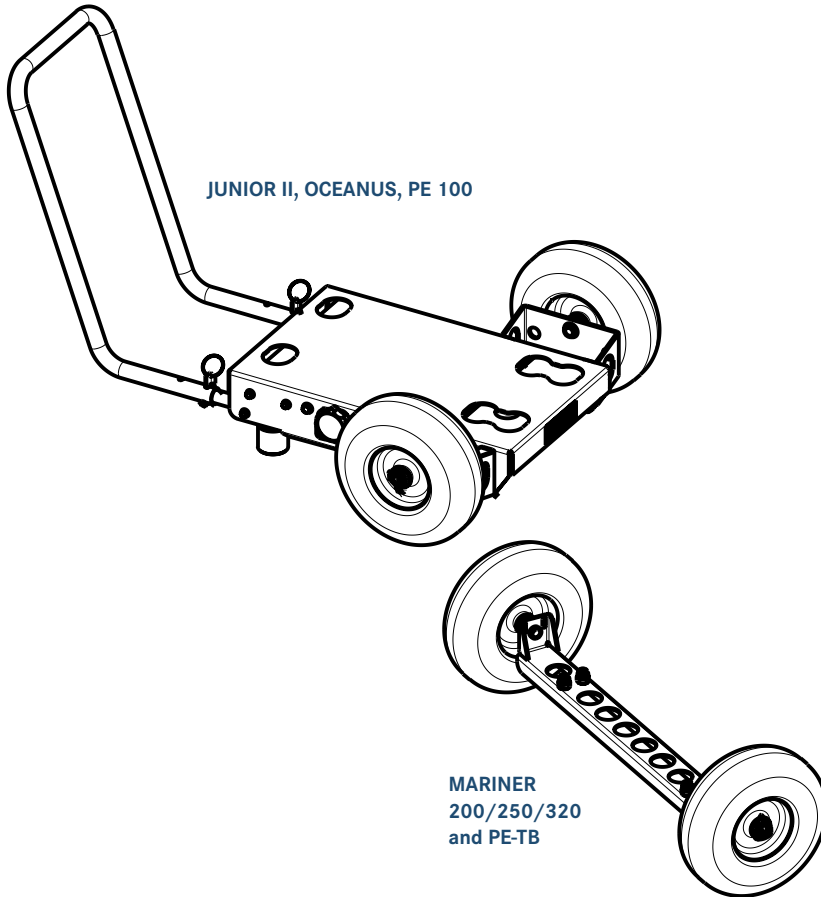

Designation	Order number
JUNIOR II, OCEANUS, PE100	168013
PE-TB	183643
MARINER 200/250	82327-KD
MARINER 320	80775-KD

SPECIAL TOOLS

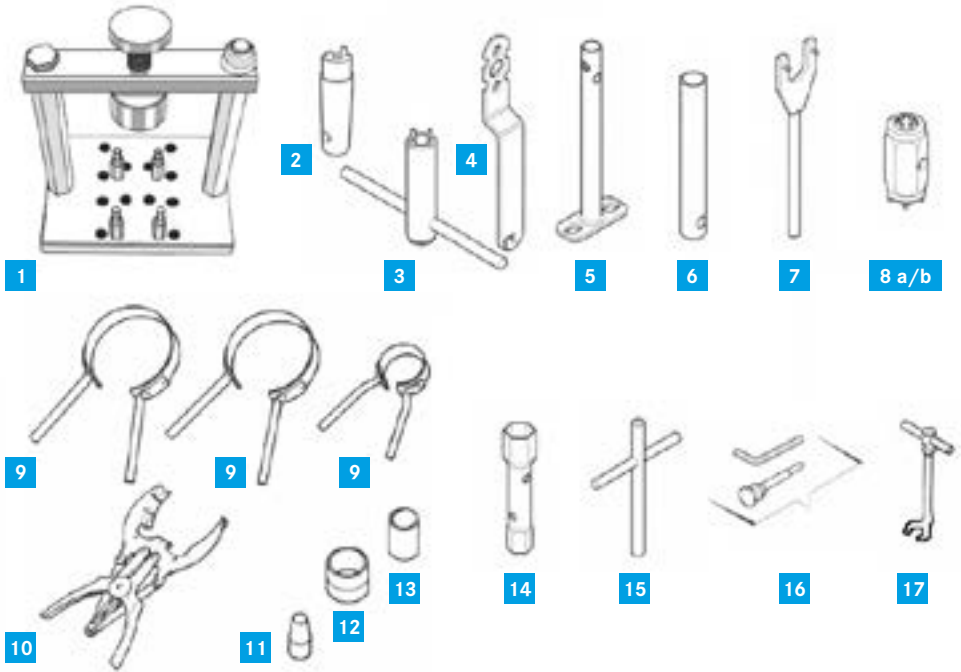





Type	Order number
1 Tool for valve installation. Makes the job significantly easier! Protects the valve head and valves! Simply clamp in the vice. Can be converted for various valve heads. (Compressor types) Can only be used in conjunction with 8a or 8b!	N32482
2 Pin spanner for pressure retention valve (repair and setting)	81193
3 4 pin spanners for pressure retention valve (repair and setting)	85154
4 P-filter spanner (for opening cover and cartridge change)	60074
5 SECCANT filter spanner (for opening and cartridge change)	66690
6 Separator spanner (for intermediate separator insert) on newer models	79846
7 Safety valve spanner (for older P21 filters with SV 061114) Repairs or settings on safety valves should only be entrusted to capable persons with up-to-date safety valve training!	57478
8 a) Valve spanner SW 24 7.6mm hole circle Ø for older valves	04555
b) Valve spanner 24 mm, 8.5 mm hole circle Ø for newer valves	82048

Type	Order number
Piston ring band 160 mm Ø 50 mm wide	65039
Piston ring band 130mm Ø 50 mm wide	65901
Piston ring band 88mm Ø 12mm wide	67976
9 Piston ring band 88mm Ø 25mm wide	57494
Piston ring band 45mm Ø 30mm wide	57498
Piston ring band 36mm Ø 20mm wide	57499
Piston ring sleeve 22 mm Ø no band but sleeve	57406
Piston ring pliers small 55-100 mm cylinder diameter	N4452
10 Piston ring pliers medium 60-120 mm cylinder diameter	N4453
Piston ring pliers large 110-160 mm cylinder diameter	N16721
Piston ring pliers maxi 160-215 mm cylinder diameter	N39888
11 Piston ring mounting sleeve 22 mm Ø	57393
12 Piston ring mounting sleeve 45mm Ø	57643
13 Piston ring mounting sleeve 18mm Ø	64823
14 SECCANT filter spanner hexagon 32 mm (for opening cover)	N29373
15 T-spanner M12 for lifting and changing jumbo cartridges	067146
16 Tool kit for inserting the clamping spring on toggle screws	067458
17 Offset claw spanner 13 mm (e.g. for nuts on cylinder foot)	N3408
Flowmeter 0-50 l/min., e.g. checking the blow-by (piston ring wear)	81187-KD
Flowmeter 0-100 l/min., e.g. checking the blow-by (piston ring wear)	81218-KD
Complete test kit for intermediate pressures. Consisting of pressure gauge 0-16 bar, 0-100 bar and 0-400 bar, 3x connection hose with connectors (N1269, N1271, N2623, N3569, N18323, N3007)	On request
Silicone sealing compound, flexible sealant for metal on metal, high-temperature connections (e.g. valve heads)	N18247
Sealing tape 12 mm wide Teflon tape DIN-DVGW	N19943
Special grease for O-rings and oil seals	072500
High-temp. grease for threads exposed to high temperatures. -180 °C to +1200 °C (e.g. output of the last stage)	N19753
Universal grease, screwed fittings of all kinds in the industrial and breathing air sector (food-stuffs certification) -30 °C to +120 °C	N19752
Thread locking agent for gluing in threads (screws, staybolts)	N25834
Thread seal for sealing conical threaded fittings	N28220
Leak detector spray (with corrosion protection) 400 ml for detecting leaks	N25833
Spray paint silver grey RAL 9006 600 ml	N26255
Spray paint turquoise blue RAL 5018 600 ml	N28410-RAL5018

TOOL RECOMMENDATIONS

Open-ended wrench	Type	Size	Set	Pieces	Order number
	Garant	5.5x7		1	N4 1832
		8x10		1	N4 1832-S01
		10x11		1	N4 1832-S02
		12x13		1	N4 1832-S03
		12x14		1	N4 1832-S04
		13x14		1	N4 1832-S05
		13x17		1	N4 1832-S06
		16x17		1	N4 1832-S07
		17x19		1	N4 1832-S08
		19x22		1	N4 1832-S09
		22x24		1	N4 1832-S10
		24x27		1	N4 1832-S11
		27x30		1	N4 1832-S12
		30x32		1	N4 1832-S13
	36x41		1	N4 1832-S14	

Ring spanner, long	Type	Size	Set	Pieces	Order number
	Garant	8		1	N4 1833
		10		1	N4 1833-S01
		11		1	N4 1833-S02
		12		1	N4 1833-S03
		13		1	N4 1833-S04
		14		1	N4 1833-S05
		16		1	N4 1833-S06
		17		1	N4 1833-S07
		19		1	N4 1833-S08
		22		1	N4 1833-S09
		24		1	N4 1833-S10
		27		1	N4 1833-S11
		30		1	N4 1833-S12
		32		1	N4 1833-S13

Socket wrench set		Type	Size	Set	Pieces	Order number
Hazet 		Smart tool case with stand-up function.		Set	1	N41834
		9 inserts 1/4 (hex) 5 - 13 mm				
		13 inserts 1/2 (hex) 11 - 27 mm				
		5 bits (hex) 2 - 6 mm				
		3 bits (slotted) 4 - 8 mm				
		2 bits (PH) 1 - 2				
		2 bits (PZ) 1 - 2				
		5 bits (for Torx®) TX10 - TX30				
		1 adapter 1/4 hex 1/4				
		3 extensions 1/4 + 1/2 101.5-248 mm				
	1 driver 1/4					
	2 ratchets 1/4 + 1/2					
Socket wrench set		Type	Size	Set	Pieces	Order number
Garant 		3/8"	8-19	Set	1	N41806
Socket wrench insert		Type	Size	Set	Pieces	Order number
Holex 		Hex	1/2"	30	1	N41807
		Hex	1/2"	32	1	N41808
		Hex, long	3/8"	5	1	N41809
Garant 		Hex, long	3/8"	6	1	N41810

TOOL RECOMMENDATIONS

Angled hex key set	Type	Size	Set	Pieces	Order number
Swiss Tools					
		1.5-10	Set	1	N41679
Hex screwdriver	Type	Size	Set	piece	Order number
Holox.		5		1	N41811
		6		1	N41812
Screwdriver set	Type	Size	Set	piece	Order number
Holox	Slot	3.5-5.5-7.8	Set	1	N41827
	Phillips	1+2			
	Pozidrive	1+2			
Slotted screwdriver	Type	Size	Set	piece	Order number
Swiss Tools	Short	4		1	N41828
					
Wera	Wide/impact cap	14		1	N41829
					
Wera	Micro	2.5		1	N41830
					
Pliers range	Type	Size	Set	piece	Order number
Holox		4	Set	1	N41831
	Universal pliers				
	Angled long nose pliers				
	Pipe wrench				
	Side cutter				
Pliers wrench	Type	Size	Set	piece	Order number
Knipex		0-60mm SW		1	N41790
					
Adjustable wrench	Type	Size	Set	piece	Order number
Holox		0-34mm SW		1	N41791
					

Circlip pliers		Type	Size	Set	piece	Order number
Holox		45° angled Inner rings	Rings 12-25Ø Tips 1.3Ø		1	N41792
Holox		Outside rings	Rings 10-25Ø Tips 1.3Ø		1	N41797
Torque wrench		Type	Size	Set	piece	Order number
Garant		3/8" 0-60 Nm	60		1	N41681
Pin punch		Type	Size	Set	piece	Order number
Rennsteig		2-8mm	6	Set	1	N41798
Centre punch		Type	Size	Set	piece	Order number
Rennsteig		5x120	120/10		1	N41799
Machinist's hammer		Type	Size	Set	piece	Order number
Garant		200g	200		1	N41800
		400g	400		1	N41801
Plastic hammer		Type	Size	Set	piece	Order number
Garant		269g	27		1	N41802
		578g	40		1	N41803
Metal saw		Type	Size	Set	piece	Order number
Bahco		300 mm			1	N41804
Metal file		Type	Size	Set	piece	Order number
Holox		Punch 2 250mm	250	Set	1	N41805
Non-woven abrasive		Type	Size	Set	piece	Order number
Holox			220		1	N41777
Manual deburring tool		Type	Size	Set	piece	Order number
Garant		90° HSS	12.4		1	N41682
Triangular scraper		Type	Size	Set	piece	Order number
Rennsteig		7x85mm			1	N41778

TOOL RECOMMENDATIONS

Universal knife	Type	Size	Set	piece	Order number
Tajima 		18mm		1	N41779
Pipe bending tool	Type	Size	Set	piece	Order number
Virax 	Niro max. 1.5mm	6		1	N41683
	Wall thickness	8		1	N41684
Block hook	Type	Size	Set	piece	Order number
Garant 		150x100mm	150x100	1	N41780
Measuring wheel	Type	Size	Set	piece	Order number
Holox 		5m	5	1	N41781
Caliper gauge	Type	Size	Set	piece	Order number
Holox 		150mm	150	1	N41782
Scriber	Type	Size	Set	piece	Order number
Holox 		230mm		1	N41783
Wire brush	Type	Size	Set	piece	Order number
Lessmann 		0.35mm Inox wire		1	N41788
Pipe pliers	Type	Size	Set	piece	Order number
VBW 		3" 106mm	3	1	N41789
LED torch	Type	Size	Set	piece	Order number
Holox 		IPX4	155	1	N41771
Magnet attachment	Type	Size	Set	piece	Order number
Holox 		520mm 10N 12Ø	1000	1	N41685
Strap wrench	Type	Size	Set	piece	Order number
Holox 			20/600	1	N41686

Oil spray can	Type	Size	Set	piece	Order number
Mato 	300ml	300		1	N41772
Roll-up tool case	Type	Size	Set	piece	Order number
Holex 	15 compartments	680x320		1	N41773
Tool case	Type	Size	Set	piece	Order number
Holex 	Max. 25 kg, wheeled	465x352x215		1	N41774
Compressed air impact wrench	Type	Size	Set	piece	Order number
Chicago Pneumatic 	3/8" 68-414 Nm max. air requirement 564 l/min	7729		1	N41775
Pry bar	Type	Size	Set	piece	Order number
Heyco 	14x14	390mm		1	N41687
Multimeter pliers	Type	Size	Set	piece	Order number
Benning	600V DC / 600V AC 10mA-300A DC 100mA-300A AC	CM2		1	N41776
Installation pliers	Type	Size	Set	piece	Order number
Knipex 	Cutting -15Ø Stripper -2.5mm ² Crimping -2.5mm ²	200		1	N41688
High performance grease	Type	Size	Set	piece	Order number
				1	N32562
	High performance universal grease in a handy 100g tube -50°C to +120°C				
High temperature grease	Type	Size	Set	piece	Order number
				1	N19753
	For threads exposed to high temperatures. -180°C to +1200°C (e.g. output of the last stage)				
Filling valve tool	Type	Size	Set	piece	Order number
		SW 36		1	124999
	For mounting valves to CEODEUX storage bottles				

OIL TYPES

Designation	Contents	Application type	Order number
Synthetic oil	1 litre	Breathing air ¹ , Industrial air	N28355-1
Synthetic oil	5 litres	Breathing air ¹ , Industrial air	N28355-5
Synthetic oil	20 litres	Breathing air ¹ , Industrial air	N28355-20
Mineral oil	1 litre	Breathing air ¹ , Industrial air	N22138-1
Mineral oil	5 litres	Breathing air ¹ , Industrial air	N22138-5
Mineral oil	20 litres	Breathing air ¹ , Industrial air	N22138-20
Synthetic oil	1 litre	Breathing air ¹ , Industrial air	N19745-1
Synthetic oil	5 litres	Breathing air ¹ , Industrial air	N19745-5
Synthetic oil	20 litres	Breathing air ¹ , Industrial air	N19745-20
Synthetic oil	1 litre	Natural gas	N26303-1
Synthetic oil	5 litres	Natural gas	N26303-5
Synthetic oil	20 litres	Natural gas	N26303-20
Synthetic oil	1 litre	Industrial, nitrogen, helium, argon	N18145-1
Synthetic oil	5 litres	Industrial, nitrogen, helium, argon	N18145-5
Synthetic oil	20 litres	Industrial, nitrogen, helium, argon	N18145-20
Synthetic oil	1 litre	Industrial, nitrogen	N30387-1
Synthetic oil	5 litres	Industrial, nitrogen	N30387-5
Synthetic oil	20 litres	Industrial, nitrogen	N30387-20
Mineral oil	5 litres	Screw compressor	N32933-05
Mineral oil	1 litre	Honda engines	073266

¹ Breathing air: approved for breathing air application in conjunction with BAUER air purification systems

OIL TYPES

GENERAL

Based on extensive test series with different lubricants, we have approved the following oils for use in BAUER compressors under the specified operating conditions. The list represents the valid status at the date of issue and is updated continuously. If the list or your operating instructions are older, please request the latest version from BAUER Customer Service.

Designation	Oil type	Approved type of use						Ambient temperature
		A Breathing air	N Nitrox	I Industrial air	G Helium, argon	C Natural gas	GI Nitrogen	
Special compressor oil order no. N28355	S	+ ^{c)}	+ ^{c)}	+ ^{d)}	+ ^{d)}	-	+ ^{d)}	+5 ... +45 °C
Special compressor oil order no. N30387	S	-	-	+ ^{d)}	+ ^{d)}	-	+ ^{d)}	+10 ... +45 °C
Special compressor oil order no. N26303	S	-	-	-	-	+ ^{d)}	-	+5 ... +45 °C
Special compressor oil order no. N22138	M	+ ^{a)}	-	+ ^{b)}	-	-	-	+5 ... +45 °C

OIL TYPE

S = synthetic oil
M = mineral oil

SUITABILITY

+ = suitable
 - = not suitable
 * = pre-heating required as necessary

CHANGE INTERVALS

Change the oil after reaching the operating hours given below, but at the latest after reaching the specified number of months:

- a)** = oil change every 500 hours or at the latest after 12 months
- b)** = oil change every 1000 hours or at the latest after 12 months
- c)** = oil change every 1000 hours or at the latest after 24 months
- d)** = oil change every 2000 hours or at the latest after 24 months

Date of delivery	Oil used on first delivery for breathing air compressors	Number of the oil used for breathing air compressors
up to August 1992	Mineral oil	N22138
from September 1990 to March 1999	Synthetic oil	N19745
from April 1999 to August 2006	Mineral oil	N22138
from August 2006 onwards	Synthetic oil	N28355

OIL

Check the precise oil fill volumes using the dipstick or oil sight glass.
For recommended oils, see the current oil list.

OIL QUANTITIES OF THE INDIVIDUAL COMPRESSOR TYPES

Compressor type	Top-up volume	Oil	Oil	Oil filter
	Litres ¹	max. litres	min. litres	(Litre)
U-10 JUNIOR JUNIOR II	-0.07	0.35	0.28	–
OCEANUS	-0.20	01.30	01.10	–
UTILUS CAPITANO MARINER	-0.25	01.75	01.50	–
UTILUS II CAPITANO II MARINER II	-0.50	02.90	02.40	Internal Internal Internal
IK 100 IK 120	-0.40	02.80	02.40	–
IK 100II IK 120II IK 12.14II	-0.50	02.90	02.40	Internal Internal Internal
K14 K14.11	-0.60	02.80	02.20	–
K15 K16 K150 K180 K18.1	-0.30	04.40	04.10	–
IK 150II IK 180II IK 18.1 II	-1.60	06.00	04.40	Internal Internal Internal
IK22.0 IK22.5	-1.75	08.50	06.75	-0.50
IK23.0 IK23.4	-2.20	10.50	08.30	-0.50
IK25.0, IK25.4, IK25.5, IK25.9, IK25.18 IK28.0, IK28.2, IK28.3	-9.00	34.00	25.00	-1.00

1 from max. to min.

PRELUBRICATION OIL PUMP

SUITABLE FOR LARGER COMPRESSORS WITH OIL PUMP LUBRICATION!

Especially when the compressors are subject to longer standstill times (more than 4 weeks), it is advisable to supply the entire lubrication system with oil before recommissioning. Prelubrication is extremely important, especially if the piston rods of the compressors are supported by bearing cups and bushes! The connection for prelubrication should be somewhere next to the oil pump. Due to the large variety of compressor types, the pump is delivered without the connecting hose to the compressor and oil reservoir (see photo)!

For more precise information, please refer to the documentation of your compressor unit!

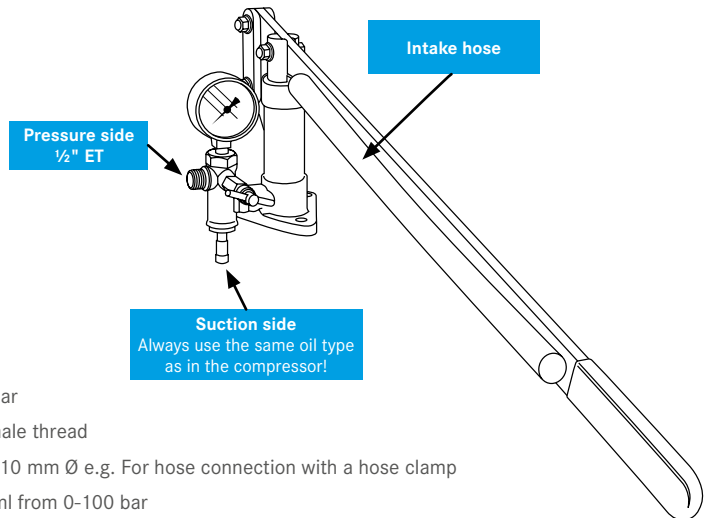

PUMP DATA

- › **Max. pump pressure:** 100 bar
- › **Pressure side output:** 1/2" male thread
- › **Suction side input:** approx. 10 mm Ø e.g. For hose connection with a hose clamp
- › **Oil amount per stroke:** 35 ml from 0-100 bar
- › **Design:** Pump and valve in non-ferrous metal, pump lever in iron.

SCOPE OF DELIVERY

Pump is delivered with a pressure gauge and approx. 500 mm intake hose.

ORDER NUMBER

N33248

AVOIDING BREAKDOWNS:

BAUER KOMPRESSOREN MAINTENANCE KITS

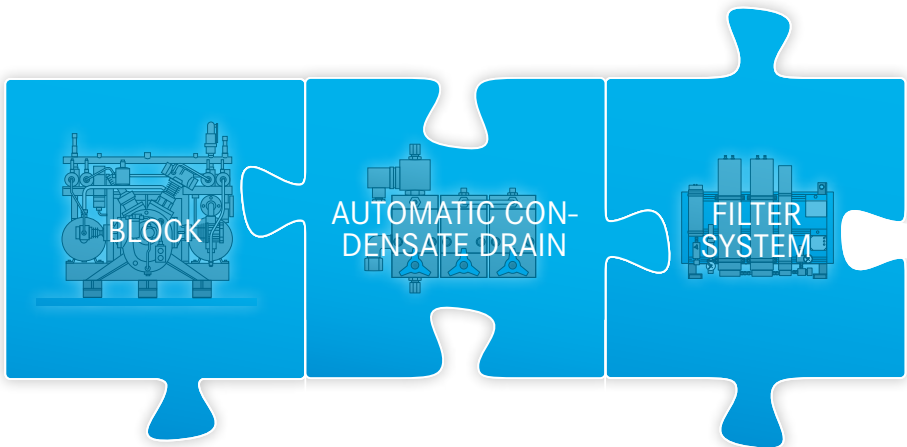

THE ADVANTAGES OF OUR MAINTENANCE KITS

- › High availability of your systems
- › Prevents unexpected breakdowns and downtimes
- › Ensure a long service life for your compressors
- › Low maintenance costs combined with high safety
- › Maintenance kits offer a price advantage compared to buying the individual spare parts
- › Reduction in repair and maintenance costs for your compressor
- › Exclusive use of BAUER genuine spare parts in tried-and-tested BAUER quality
- › Technical documentation (spare parts lists) 1985 - today: DVD article no. N28763

BAUER KOMPRESSOREN MAINTENANCE KITS

EXPLANATION OF TERMS

- › **A** = breathing air
- › **I** = industrial air / dry gases old
- › **D** = dry gases
- › **G** = natural gas / dry gases old

Example: Spare parts list A1, IK100, production status 2, breathing air, appropriate maintenance kit = A-100-F2/3-abc1

In some old maintenance kits for GI systems, the "I" kit or the "G" kit may still be valid instead of the "D" kit. No new "D" kit is created for a small number of blocks with an old production status.



HOW DO I FIND THE RIGHT BLOCK MAINTENANCE KIT IN THE TABLE?

After how many operating hours do I require the maintenance kit?

A Maintenance kits

- 500h = a1
- 1000h = ab1
- 2000h = abc1

I,D,G Maintenance kits

- 1000h = a1
- 2000h = ab1
- 4000h = abc1

Production status?

Depending on the year and month of manufacture

What compressor block do I have?

What is compressed?

- A = Breathing air
- I = Industrial air
- D = Dry gases
- G = Natural gas

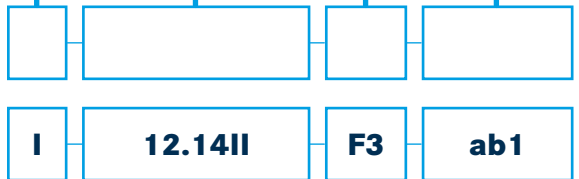

AN EXAMPLE:

You own an industrial air compressor, IK**12.14**, built in 01/2004, with production status **F3** and you want to carry out a **2000h** maintenance.

You would have to order the following maintenance kit: **I-12.14II-F3-ab1**

Block / A-list	Block	Sector	Additional inf.	1	2	3	4	5	6	7
Not specified	PE100	Breathing air					"A-PE100-F4-abc1 01/2011 - dato"			
Not specified	JUNIOR (+U10)	Breathing air		"A-JUNIOR-F1/3-abc1 02/1993 - 04/1998"	"A-JUNIOR-F1/3-abc1 02/1993 - 04/1998"	"A-JUNIOR-F1/3-abc1 02/1993 - 04/1998"				
Not specified	JUNIOR II	Breathing air				"A-JUNIOR II-F3-abc1 05/1999 - 12/2001"	"A-JUNIOR II-F4-abc1 01/2001 - dato"			
Not specified	PURUS (+VARIUS / U10)	Breathing air		"A-PURUS-F1-abc1 - 02/86 Attention not for VARIUS - 02/86 due to different piston / sleeve"	"A-PURUS-F2-abc1 03/1986 - 01/1993"					
A41.	IK80-G	"No kit (low quantity of blocks)"		"No kit available 27.05.1983"						
A11.	UTILUS, K13	Breathing air		"No kit available 16.05.1972"	"No kit available 12.02.1973"	"No kit available 03.04.1973"	"No kit available 25.10.1973"	"No kit available 21.01.1974"	"A-UTILUS-F6/7-abc1 01.01.1975"	"A-UTILUS-F6/7-abc1 01.01.1976"
A13.	K13/02	Breathing air								
A9.	MARINER	Breathing air		"No kit available 06.06.1972"	"A-MARINER-F2/3-abc1 07.02.1973"	"A-MARINER-F2/3-abc1 25.10.1973"				
A10.	CAPITANO	Breathing air		"A-Cap-F1/7-abc1 06.06.1972"	"A-Cap-F1/7-abc1 07.02.1973"	"A-Cap-F1/7-abc1 25.10.1973"	"A-Cap-F1/7-abc1 01.01.1975"	"A-Cap-F1/7-abc1 01.01.1976"	"A-Cap-F1/7-abc1 01.01.1978"	"A-Cap-F1/7-abc1 01.01.1980"
A125	OCEANUS	Breathing air		A-OCEANUS-F1-abc1						
A1.	IK100	Breathing air		"A-100-F1-abc1 03.12.1984"	"A-100-F2/3-abc1 21.11.1986"	"A-100-F2/3-abc1 01.03.1996"				
A1.	IK100	Industrial air		"I-100-F1-abc1 03.12.1984"	"I-100-F2/3-abc1 21.11.1986"	"I-100-F2/3-abc1 01.03.1996"				
A1.	IK100II	Breathing air					"A-100II-F4-abc1 01.02.2000"	"A-100II-F5-abc1 01.01.2004"	"A-100II-F6-abc1 01.06.2004"	"A-100II-F7-abc1 01.08.2005"
A1.	IK100II	Industrial air					"I-100II-F4-abc1 01.02.2000"	"I-100II-F5-abc1 01.01.2004"	"I-100II-F6-abc1 01.06.2004"	"I-100II-F7-abc1 01.08.2005"
A41.	IK100-C	Natural gas			"I-100-F2/3-abc1 24.03.1987"	"I-100-F2/3-abc1 01.03.1996"				
A41.	IK100II-C	Natural gas					"I-100II-F4-abc1 01.02.2000"	"G-100II-F5/6-abc1 01.01.2004"	"G-100II-F5/6-abc1 01.08.2005"	

8	9	10	11	12	13	14	15	16	17	18
---	---	----	----	----	----	----	----	----	----	----

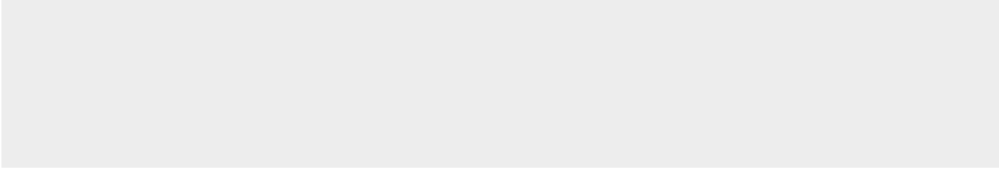
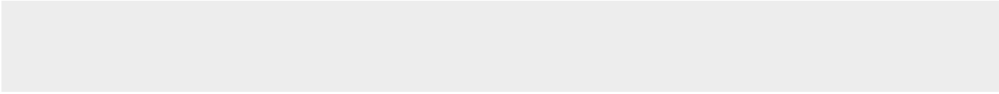

"A-UTILUS-
F8-abc1
01.01.1978"

"A-UTILUS-
F9-abc1
01.01.1980"

"A-UTILUS-
F9-abc1
01.01.1980"

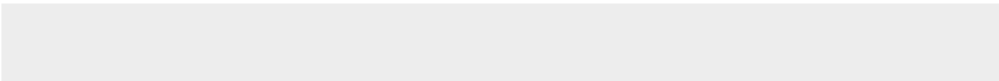
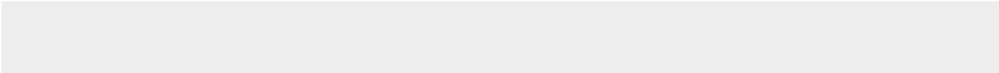
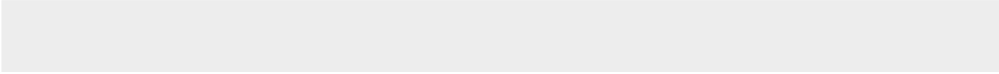

Block / A-list	Block	Sector	Additional inf.	1	2	3	4	5	6	7
A41.	IK100-GI	Dry gases			"I-100-F2/3-abc1 24.03.1987"	"I-100-F2/3-abc1 01.03.1996"				
A41.	IK100II-GI	Dry gases					"I-100II-F4-abc1 01.02.2000"	G-100II-F5/6-abc1 01.01.2004	D-100II-F6-abc1 01.06.2004	
A41.	IK100-G	Dry gases		"No kit available 27.05.1983"	"I-100-F2/3-abc1 24.03.1987"	"I-100-F2/3-abc1 01.03.1996"				
A41.	IK100II-G	Natural gas / Dry gases					"I-100II-F4-abc1 01.02.2000"	"G-100II-F5/6-abc1 01.01.2004"	"D-100II-F6-abc1 01.06.2004"	
A1.-H	IK100II-420	Industrial air					"I-100II-420-F4/5-abc1 01.08.2005"	"I-100II-420-F4/5-abc1 01.08.2005"		
A14.	IK11.0	"No kit (low quantity of blocks)"		"No kit available 14.06.1988"	"No kit available 01.03.1998"	"No kit available 25.09.2000"				
A50.	IK11.0-G	"No kit (low quantity of blocks)"		"No kit available 29.11.1990"	"No kit available 01.08.1998"					
A50.	IK11.0-C	"No kit (low quantity of blocks)"		"No kit available 29.11.1990"	"No kit available 01.03.1998"					
A1.	IK120	Breathing air		"A-120-F1-abc1 03.12.1984"	"A-120-F2-abc1 21.11.1986"	"A-120-F3-abc1 01.03.1996"				
A1.	IK120	Industrial air		"A-120-F1-abc1 03.12.1984"	"I-120-F2/3-abc1 21.11.1986"	"I-120-F3-abc1 01.03.1996"				
A1.	IK120II	Breathing air					"A-120II-F4-abc1 01.02.2000"	"A-120II-F5-abc1 01.01.2004"	"A-120II-F6-abc1 01.06.2004"	"A-120II-F7-abc1 01.08.2005"
A1.	IK120II	Industrial air					I-120II-F4-abc1 01.02.2000	I-120II-F5-abc1 01.01.2004	I-120II-F6-abc1 01.06.2004	I-120II-F7-abc1 01.08.2005
A41.	IK120-G	Dry gases		"I-120-F1-abc1 27.05.1983"	"G-120-F2/3-abc1 24.03.1987"	"G-120-F2/3-abc1 01.03.1996"				
A41.	IK120II-G	Dry gases					"G-120II-F4-abc1 01.02.2000"	"D-120II-F5/7-abc1 01.01.2004"	"D-120II-F5/7-abc1 01.08.2005"	
A54.	IK120-G-V009	Dry gases				"G-120-F2/3-abc1 15.05.1997"				
A41.	IK120-GI	Dry gases			"G-120-F2/3-abc1 24.03.1987"	"G-120-F2/3-abc1 01.03.1996"				
A41.	IK120II-GI	Dry gases					"G-120II-F4-abc1 01.02.2000"	"D-120II-F5/7-abc1 01.01.2004"	"D-120II-F5/7-abc1 01.08.2005"	
A41.	IK120-C	Natural gas			"G-120-F2/3-abc1 24.03.1987"	"G-120-F2/3-abc1 01.03.1996"				

8	9	10	11	12	13	14	15	16	17	18
---	---	----	----	----	----	----	----	----	----	----

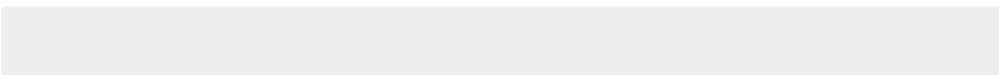
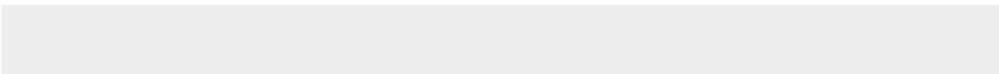
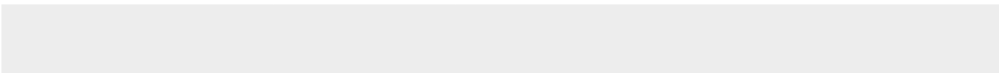
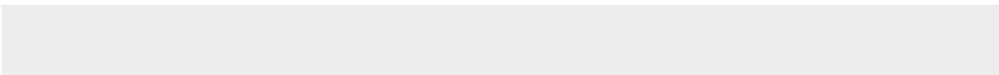
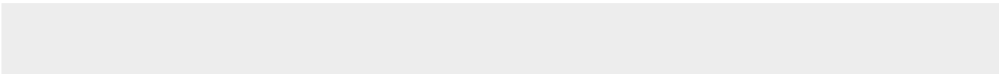
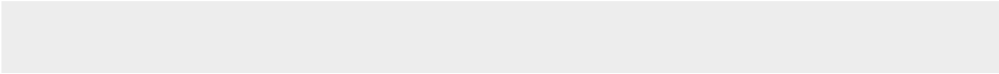

Block / A-list	Block	Sector	Additional inf.	1	2	3	4	5	6	7
A41.	IK120II-C	Natural gas					"G-120II- F4-abc1 01.02.2000"	"G-120II- F5/7-abc1 01.01.2004"	"G-120II- F5/7-abc1 01.08.2005"	
A41.	IK120II-GI-J	Dry gases							"D-120II- F5/7-abc1 01.08.2005"	
A92.	BK12.2	Breathing air		"I-12.2- F2-abc1 12.08.1991"	"A-12.2- F3/4-abc1 01.01.1996"	A-12.2- F3/4-abc1 01.04.1997				
A92.	BK12.2	Dry gases		I-12.2- F2-abc1 12.08.1991	"I-12.2- F3/4-abc1 01.01.1996"	"I-12.2- F3/4-abc1 01.04.1997"				
A92.	BK12.2II	Industrial air					"I-12.2II- F5/6-abc1 01.02.2000"	"I-12.2II- F5/6-abc1 01.01.2004"	"I-12.2II- F7-abc1 01.08.2005"	
A92.	BK12.2II	Dry gases					"I-12.2II- F5/6-abc1 01.02.2000"	"I-12.2II- F5/6-abc1 01.01.2004"	"I-12.2II- F7-abc1 01.08.2005"	
A99.	BK12.3II	Dry gases		"I-12.3II- F1/2-abc1 01.04.2005"	"I-12.3II- F1/2-abc1 01.06.2007"	"I-12.3II- F3-abc1 01.09.2008"				
A25.	IK12.4	"Industrial air ATTENTION: IK is not BK!"		"I-12.4- F1-abc1 01.01.1986"	"I-12.4- F2/3-abc1 16.04.1987"	"I-12.4- F2/3-abc1 01.03.1996"				
A90.	BK12.4	"Industrial booster AT- TENTION: BK is not IK!"		"G-12.4- F1-abc1 01.10.1989"						
A62.	IK12.4-G	"Natural gas / Dry Gases ATTENTION: IK is not BK!"		"I-12.4- F1-abc1 01.11.1986"						
A25.	IK12.4II	"Industrial air ATTENTION: IK is not BK!"					"I-12.4II- F4-abc1 01.02.2000"	"I-12.4II- F5-abc1 01.01.2004"	"I-12.4II- F6/7-abc1 01.06.2004"	
A62.	IK12.4-G	"Natural gas / Dry Gases ATTENTION: IK is not BK!"		"I-12.4- F1-abc1 01.11.1986"						
A62.	IK12.4II-G	"Natural Gas / Dry Gases ATTENTION: IK is not BK!"							"D-12.4II- F6-abc1 01.06.2004"	
A73.	IK12.4II-GI	"Dry Gases ATTENTION: IK is not BK!"					I-12.4II- F4-abc1 01.02.2000			
A71.	IK12.4II-GI/ N2O	"Dry Gases ATTENTION: IK is not BK!"					"I-12.4II- F4-abc1 01.02.2000"			
A17.	IK12.14	Breathing air		"A-12.14II- F1/2-abc1 01.02.2000"	"A-12.14II- F1/2-abc1 16.05.2002"	"A-12.14II- F3-abc1 01.01.2004"	"A-12.14II- F4/6-abc1 01.06.2004"	Not manufac- tured	"A-12.14II- F4/6-abc1 01.11.2005"	"A-12.14II- F7/8-abc1 04/2017 "
A17.	IK12.14	Industrial air		"I-12.14II- F1/2-abc1 01.02.2000"	"I-12.14II- F1/2-abc1 16.05.2002"	"I-12.14II- F3-abc1 01.01.2004"	"I-12.14II- F4/6-abc1 01.06.2004"	Not manufac- tured	"I-12.14II- F4/6-abc1 01.11.2005"	"I-12.14II- F7/8-abc1 04/2017"

8	9	10	11	12	13	14	15	16	17	18
---	---	----	----	----	----	----	----	----	----	----

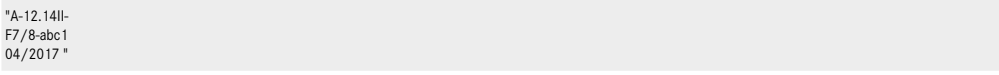
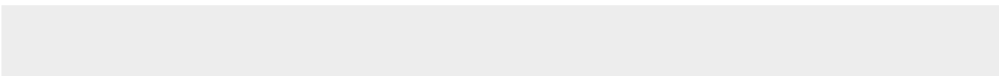
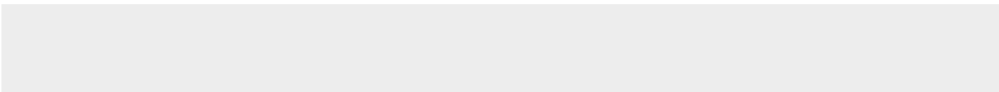
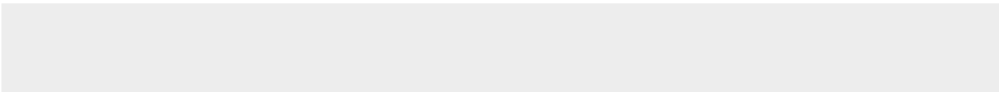
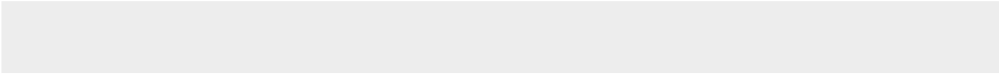

"A-12.14II-
F7/8-abc1
04/2017 "

"I-12.14II-
F7/8-abc1
04/2017"

8	9	10	11	12	13	14	15	16	17	18
"A-12.14OX4-F7/8-abc1 04/2017"										
"A-14-F7/8-abc1 01.09.1997"										
"I-14-F7/8-abc1 01.09.1987"										
"I-140-F7/8-abc1 01.09.1987"										
"I-140-F7/8-abc1 01.09.1987"										
"A-14.11-F7-abc1 01.09.1997"										
"A-14.11-F7-abc1 01.09.1997"										
"A-14.11-F7-abc1 01.09.1997"										
			"A-15.11I-F11-abc1 12.03.2002"	"A-15.11I-F12/13-abc1 01.10.2006"	"A-15.11I-F12/13-abc1 01.06.2012"	"A-15.11I-F14-abc1 01.01.2016"				
			"I-15.11I-F11-abc1 12.03.2002"	"I-15.11I-F12/13-abc1 01.10.2006"	"I-15.11I-F12/13-abc1 01.06.2012"	"I-15.11I-F14-abc1 01.01.2016"				
			"A-15.11IOX4-F11-abc1 12.03.2002"	"A-15.10X-F12/14-abc1 01.10.2006"	"A-15.10X-F12/14-abc1 01.06.2012"	"A-15.10X-F12/14-abc1 01.02.2016"				
			"D-15.11I-F11-abc1 12.03.2002"	"D-15.11I-F12/13-abc1 01.10.2006"	"D-15.11I-F12/13-abc1 01.06.2012"	"D-15.11I-F14-abc1 24.01.2017"				
"No kit available 01.10.1992"	"G-15.1-F10-abc1 01.07.1997"	"Continued IK15.1-G/-C=A56"								
			"G-15.11I-F11/13-abc1 01.10.2001"	"G-15.11I-F11/13-abc1 01.10.2006"	"G-15.11I-F11/13-abc1 01.06.2012"	"G-15.11I-F14-abc1 24.01.2017"				

Block / A-list	Block	Sector	Additional inf.	1	2	3	4	5	6	7
A56.	IK15.1II-C	Natural gas								
A19.	IK15.1III	Breathing air		"A-15.1III- F1-abc1 12.03.2002"	"A-15.1III- F2/3-abc1 01.10.2006"	"A-15.1III- F2/3-abc1 01.06.2012"	"A-15.1III- F4-abc1 01.2017"			
A19.	IK15.1III	Industrial air		"I-15.1III- F1-abc1 12.03.2002"	"I-15.1III- F2/3-abc1 01.10.2006"	"I-15.1III- F2/3-abc1 01.06.2012- 2017"	"I-15.1III- F4-abc1 01.2017"			
A57.	IK15.1III-GI	Dry gases		"D-15.1III- F1-abc1 12.03.2002"	"D-15.1III- F2/3-abc1 01.10.2006"	"D-15.1III- F2/3-abc1 01.06.2012- 2017"	"D-15.1III- F4-abc1 01.2017"			
A59.	IK15.2II-C	Natural gas		"G-15.2II- F1-abc1 01.10.2001"	"G-15.2II- F2-abc1 01.10.2006"	"G-15.2II- F3-abc1 01.06.2012"				
A96.	BK15.3II	Industrial air / dry gases		"I-15.3II- F1-abc1 01.03.2002"	"I-15.3II- F2/3-abc1 01.10.2006"	"I-15.3II- F2/3-abc1 01.10.2007"	"I-15.3II- F4-abc1 01.06.2012"	"I-15.3II- F5-abc1 01.04.2018"		
A97.	BK15.4II-C	Natural gas / dry gases		"G-15.4II- F1-abc1 01.03.2002"	"G-15.4II- F2-abc1 01.10.2006"	"G-15.4II- F3-abc1 01.06.2012"				
A132	BK15.4III-GI	Dry gases		"D-15.4III- F1-abc1 08.2017 "						
A3.	K150	Breathing air								"A-150- F7/9-abc1 11.05.1982"
A3.	K150	Industrial air								"I-150- F7/9-abc1 11.05.1982"
A3.	K150II	Breathing air								
A3.	K150II	Industrial air								
A43.	IK150-G	Natural gas								
A43.	IK150-G	Dry gases								"I-150- F7/9-abc1 11.05.1982"
A43.	IK150-GI	Dry gases								
A58.	IK150II-GI	Dry gases								
A85.	BK150-CNG	"No kit (low quantity of blocks)"		"No kit available 15.08.1986"						
A39.	IK15.7	Industrial air		"I-15.7- F1-abc1 01.07.2012"						

8	9	10	11	12	13	14	15	16	17	18
---	---	----	----	----	----	----	----	----	----	----

"G-15.1II- F11/13-abc1 01.10.2001"	"G-15.1II- F11/13-abc1 01.10.2006"	"G-15.1II- F11/13-abc1 01.06.2012"
--	--	--

--	--	--	--	--	--	--	--	--	--	--

--	--	--	--	--	--	--	--	--	--	--

--	--	--	--	--	--	--	--	--	--	--

"A-150- F7/9-abc1 06.04.1990"	"A-150- F7/9-abc1 01.07.1997"
-------------------------------------	-------------------------------------

"I-150- F7/9-abc1 06.04.1990"	"I-150- F7/9-abc1 01.07.1997"
-------------------------------------	-------------------------------------

"A-150II- F10-abc1 01.01.2001"	"A-150II- F11-abc1 01.10.2006"	"A-150II- F12-abc1 01.06.2012"	"A-150II- F13-abc1 01.02.2017"
--------------------------------------	--------------------------------------	--------------------------------------	--------------------------------------

"I-150II- F10-abc1 01.01.2001"	"I-150II- F11-abc1 01.10.2006"	"I-150II- F12-abc1 01.06.2012"	"I-150II- F13-abc1 01.02.2017"
--------------------------------------	--------------------------------------	--------------------------------------	--------------------------------------

"G-150-F9-
abc1 1992"

"I-150-
F7/9-abc1
06.04.1990"

"I-150- F7/9-abc1 01.10.1992"	"Continued IK150 GI =A58"
-------------------------------------	---------------------------------

"D-150II- F10/12-abc1 15.02.2002"	"D-150II- F10/12-abc1 01.10.2006"	"D-150II- F10/12-abc1 01.06.2012"	"D-150II- F13-abc1 01.02.2017"
---	---	---	--------------------------------------

--	--	--	--	--	--	--	--	--	--	--

Block / A-list	Block	Sector	Additional inf.	1	2	3	4	5	6	7
A117.	IK15.7-G	Natural gas		"G-15.7-F1-abc1 01.07.2012"						
A117.	IK15.7-GI	Dry gases		"D-15.7-F1-abc1 01.07.2012"						
A81.	BK15.9	"No kit (low quantity of blocks)"		"No kit available 01.10.1985"						
A26.	IK17.0	"No kit (low quantity of blocks)"		"I-17-F1/2-abc1 15.11.1986"	"I-17-F1/2-abc1 13.12.1989"					
A63.	IK17.0-G	"No kit (low quantity of blocks)"		"I-17-F1/2-abc1 15.11.1986"						
A86.	BK17.2	"No kit (low quantity of blocks)"		"No kit available 22.06.1987"						
A15.	IK18.1	Breathing air		"A-18.1-F1-abc1 25.01.1990"	"A-18.1-F2/3-abc1 01.07.1997"	"A-18.1-F2/3-abc1 01.12.1998"				
A15.	IK18.III	Breathing air					"A-18.III-F4/5-abc1 01.10.2001"	"A-18.III-F4/5-abc1 01.04.2005"	"A-18.III-F6/7-abc1 01.10.2006"	"A-18.III-F6/7-abc1 01.04.2011"
A15.	IK18.1	Industrial air		"I-18.1-F1-abc1 25.01.1990"	"I-18.1-F2/3-abc1 01.07.1997"	"I-18.1-F2/3-abc1 01.12.1998"				
A15.	IK18.III	Industrial air					"I-18.III-F4/5-abc1 01.10.2001"	"I-18.III-F4/5-abc1 01.04.2005"	"I-18.III-F6/7-abc1 01.10.2006"	"I-18.III-F6/7-abc1 01.04.2011"
A48.	IK18.1-G	Natural gas / Dry gases		"I-18.1-F1-abc1 25.01.1990"	"I-18.1-F2/3-abc1 01.07.1997"	"I-18.1-F2/3-abc1 01.12.1998"				
A48.	IK18.1-GI	Dry gases		"D-18.1-F1-abc1 25.01.1990"	"D-18.1-F2/3-abc1 01.07.1997"	"D-18.1-F2/3-abc1 01.12.1998"				
A75.	IK18.III-G	Natural gas / Dry gases					"G-18.III-F4/5-abc1 01.10.2001"	"G-18.III-F4/5-abc1 01.04.2005"	"G-18.III-F6/7-abc1 01.10.2006"	"G-18.III-F6/7-abc1 01.04.2011"
A74.	IK18.III-GI	Dry gases					"D-18.III-F4/5-abc1 01.10.2001"	"D-18.III-F4/5-abc1 01.04.2005"	"D-18.III-F6/7-abc1 01.10.2006"	"D-18.III-F6/7-abc1 01.04.2011"
A48.	IK18.1-C	Natural gas		"I-18.1-F1-abc1 25.01.1990"	"I-18.1-F2/3-abc1 01.07.1997"	"G-18.1-F3-abc1 01.12.1998"				
A20. (A3)	K180	Breathing air			"A-180-F2-abc1 02.06.1982"	"A-180-F3/4-abc1 06.04.1990"	"A-180-F3/4-abc1 01.07.1997"			
A20. (A3)	K180	Industrial air			"I-180-F2-abc1 02.06.1982"	"I-180-F3/4-abc1 06.04.1990"	"I-180-F3/4-abc1 01.07.1997"			
A20.	K180II	Breathing air					"A-180II-F5/6-abc1 01.10.2001"	"A-180II-F5/6-abc1 01.10.2006"	"A-180II-F7-abc1 01.02.2012"	

8	9	10	11	12	13	14	15	16	17	18
---	---	----	----	----	----	----	----	----	----	----

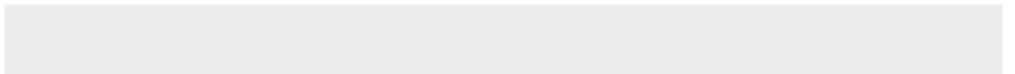
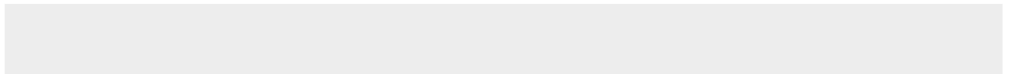
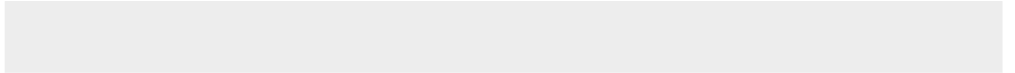
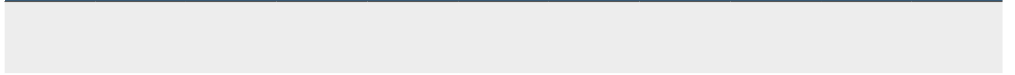

"A-18.1II-
F8-abc1
01.06.2012" "A-18.1II-F9-
abc1 01.01-
2017"

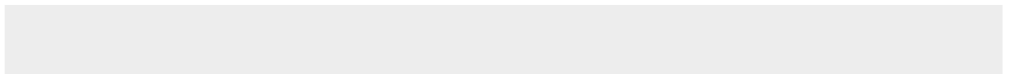

"I-18.1II-
F8-abc1
01.06.2012" "I-18.1II-F9-
abc1 01.01-
2017"

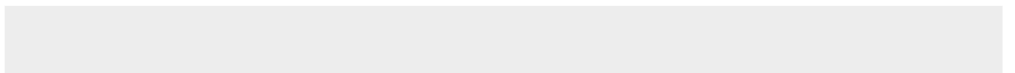

"G-18.1II-
F8abc1
01.06.2012" "G-18.1II-F9-
abc1 01.01-
2017"



"D-18.1II-
F8abc1
01.06.2012" "D-18.1II-F9-
abc1 01.01-
2017"

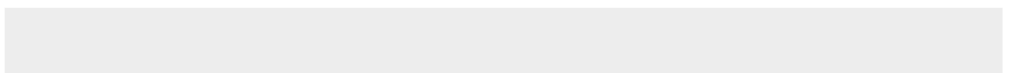

"A-180II-
F8-abc1
01.01.2017"



Block / A-list	Block	Sector	Additional inf.	1	2	3	4	5	6	7
A20.	K180II	Industrial air						I-180II- F5/6-abc1 01.10.2001	"I-180II- F5/6-abc1 01.10.2006"	"I-180II- F7-abc1 01.02.2012"
A43.	IK180-GI	Dry gases		"I-180- F2-abc1 02.06..1982"	"I-180- F3/4-abc1 06.04.1990"	"I-180- F3/4-abc1 01.10.1992"		"Continued IK180 GI= A60"		
A60.	IK180II-GI	Dry gases						"D-180II- F5/6-abc1 01.10.2001"	"D-180II- F5/6-abc1 01.10.2006"	"D-180II- F7-abc1 01.02.2012"
A43.	IK180-G	Natural gas				"I-180- F3/4-abc1 06.04.1990"				
A4.	K200	"No kit (low quantity of blocks)"					"No kit available 04.10.1982"			
A5.	K21	Industrial air		"No kit available 16.03.1977"	"No kit available 01.01.1978"	Not manufac- tured	"No kit available 15.02.1980"	"No kit available 05.05.1981"	"No kit available 05.05.1981"	"No kit available 05.10.1981"
A44.	IK21-G	Natural gas						"No kit available 05.10.1981"	"G-21.0- F6/7-abc1 01.05.1985"	
A21.	IK21.4	"No kit (low quantity of blocks)"		"No kit available 16.07.1985"						
A6.	K22.0	Breathing air		"No kit available 28.0.01.1983"	"I-22.0- F2/3-abc1 25.01.1985"	"I-22.0- F2/3-abc1 01.03.1986"	"A-22.0- F4/5-abc1 09.01.1992"	"A-22.0- F4/5-abc1 01.01.1995"	"A-22.0- F6-abc1 22.04.2015"	
A6.	K22.0	Industrial air			"I-22.0- F2/3-abc1 25.01.1985"	"I-22.0- F2/3-abc1 01.03.1986"	"I-22.0- F4/5-abc1 09.01.1992"	"I-22.0- F4/5-abc1 01.01.1995"	"I-22.0- F6-abc1 22.04.2015"	
A45/6	K22.0-420	Industrial air	420 Bar version	"I-22.0-420- F1-abc1 22.04.2015"						
A45.	IK22.0-G	Natural gas / Dry gases			"D-22.0- F2/3-abc1 25.01.1985"	"D-22.0- F2/3-abc1 01.03.1986"	"D-22.0- F4/5-abc1 01.01.1992"	"D-22.0- F4/5-abc1 01.01.1995"	"D-22.0- F6-abc1 22.04.2015"	
A45.	IK22.0-C	Natural gas				"G-22.0- F2/3-abc1 01.03.1986"	"G-22.0- F4/5-abc1 01.01.1992"	"G-22.0- F4/5-abc1 01.01.1995"	"G-22.0- F6-abc1 22.04.2015"	
A45.	IK22.0-GI	Dry gases					"D-22.0- F4/5-abc1 01.01.1992"	"D-22.0- F4/5-abc1 01.01.1995"	"D-22.0- F6-abc1 22.04.2015"	
A29.	IK22.2	Breathing air		"A-22.2- F1-abc1 21.07.1992"	"A-22.2- F2-abc1 01.01.1995"					
A22.	IK22.5	Industrial air		"I-22.5- F1/2-abc1 18.01.1985"	"I-22.5-F1/2- abc1 09.01- 1992"	"I-22.5- F3-abc1 01.01.1995"				
A61.	IK22.5-G	Natural gas / dry gases		"I-22.5- F1/2-abc1 18.01.1985"	"I-22.5-F1/2- abc1 09.01- 1992"	"I-22.5- F3-abc1 26.10.1994"				
A72.	IK22.5-GI/ N2O	Dry gases				"D-22.5- F3-abc1 26.10.1994"				

8	9	10	11	12	13	14	15	16	17	18
---	---	----	----	----	----	----	----	----	----	----

"I-180I-
F8-abc1
01.01.2017"

"D-180II-
F8-abc1
01.01.2017"

"I-21.0- "I-21.0-
F8-abc1 F8-abc1
17.01.1984" 14.07.1987"

8	9	10	11	12	13	14	15	16	17	18
---	---	----	----	----	----	----	----	----	----	----

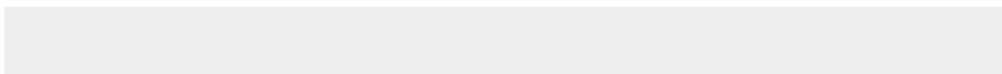
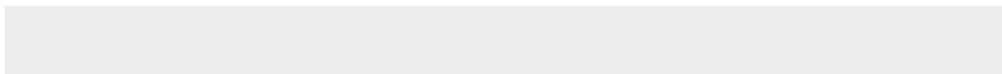
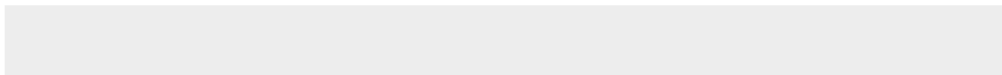
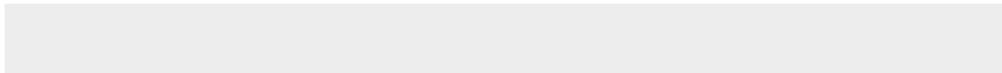
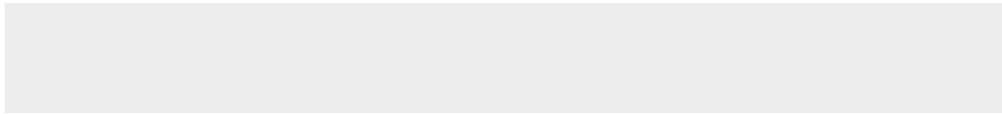

"A-23.0- F11/13-abc1 07.06.1989"	"A-23.0- F11/13-abc1 02.04.1990"	"A-23.0- F11/13-abc1 20.01.1992"	"A-23.0- F11/13-abc1 26.10.1993"	"A-23.0- F11/13-abc1 31.01.1993"	"A-23.0- F14-abc1 01.04.2015 Attention old design!"
--	--	--	--	--	---

"I-23.0- F11/13-abc1 07.06.1989"	"I-23.0- F11/13-abc1 02.04.1990"	"I-23.0- F11/13-abc1 20.01.1992"	"I-23.0- F11/13-abc1 26.10.1993"	"I-23.0- F11/13-abc1 31.01.1993"	"I-23.0- F14-abc1 01.04.2015 Attention old design!"
--	--	--	--	--	---

					"I-23.0-W- F14-abc1 01.01.2005"
--	--	--	--	--	---------------------------------------

Block / A-list	Block	Sector	Additional inf.	1	2	3	4	5	6	7
A5.	K23.0-W	"Industrial air water-cooled new design modular"								
A5.-W	K23.0-W-V/H	"Industrial air water-cooled new design modular"								
A5.-L	K23.0-L-V/H	"Industrial air air-cooled new design modular"								
A44.	IK23.0-G	Natural gas / Dry gases								"G-23.0-F7/12-abc1 02.01.1989"
A44.	IK23.0-C	Natural gas								"G-23.0-F7/12-abc1 02.01.1989"
A44.-C-L	IK23.0-C-L	"Natural gas air-cooled new design"								
A44.-C-W	IK23.0-C-W	"Natural gas water-cooled new design"								
A44.	IK23.0-GI	"Dry gases old design"								
A44.-GI-W	IK23.0-GI-W	"Dry gases water-cooled new design"								
A44.-GI-L	IK23.0-GI	"Dry gases air-cooled new design"								
A52.	IK23.1-G	"Natural gas / dry gases old design"								
A52.	IK23.1-C	"Natural gas old design"								
A52.	IK23.1-C	"Natural gas water-cooled"								
A77.	IK23.2	"Industrial air water-cooled"			"I-23.2-W-F2-abc1 01.04.2008"					
A77.	IK23.2-W-V/-H	"Industrial air water-cooled new design modular"								"I-23.2-W-F2-abc1 01.03.2010"

Block / A-list	Block	Sector	Additional inf.	1	2	3	4	5	6	7
A77.	IK23.2-GI-W-V/-H	"Dry gases water-cooled new design modular"			"D-23.2-W-F2-abc1 01.03.2010"					
A77.	IK23.2-G-W-V/-H	"Natural/ dry gases water-cooled new design modular"			"D-23.2-W-F2-abc1 01.03.2010"					
A77.-L	IK23.2-G-L-V/-H	"Natural / dry gases air-cooled new design modular"		"D-23.2-L-F1-abc1 01.04.2008"						
A78.	IK23.2-C-W-V/-H	"Natural gas water-cooled new design modular"		"G-23.2-F01-abcd1 01.04.2008"	"G-23.2-W-F2-abcd1 01.03.210"					
A21.	IK23.4	Industrial air			"I-23.4-F2/4-abc1 28.10.1987"	"I-23.4-F2/4-abc1 20.01.1992"	"I-23.4-F2/4-abc1 31.01.1994"	"I-23.4-F5-abc1 01.01.1995"	"I-23.4-F6-abc1 01.03.2013"	
A64.	IK23.4-G	Natural gas / Dry gases			"D-23.4-F2/4-abc1 28.10.1987"	"D-23.4-F2/4-abc1 20.01.1992"	"D-23.4-F2/4-abc1 31.01.1994"	"D-23.4-F5-abc1 01.01.1995"		
A64.	IK23.4-GI	Dry gases						"D-23.4-F5-abc1 01.01.1995"		
A114.	BK23.5-GI	"Dry gases water-cooled"	Swagelock	"D-23.5-F1-abc1 01.12.2011"						
A110.-W	BK23.7-C/-W-V/-H	"Natural gas water-cooled"		"G-23.7-F1-abc1 01.07.2010"						
A110.-W	BK23.7-GI/-G-W-V/-H	"Dry gases water-cooled"		"D-23.7-W-F1-abc1 01.07.2010"						
A-110-L	BK23.7-GI/-G-L-V/-H	"Dry gases air-cooled"		"D-23.7-L-F1-abc1 01.07.2010"						
A110.-L	BK23.7-C/-L-V/-H	"Natural gas air-cooled"		"G-23.7-F1-abc1 01.07.2010"						
	IK23.8	Industrial air		"I-23.8-F1/2-abc1 12.2009"	"I-23.8-F1/2-abc1 "					
A109.-W	BK23.8-C-W-V/-H	"Natural gas water-cooled"		"G-23.8-W-F1/2-abc1 01.12.2009"	"G-23.8-W-F1/2-abc1 01.03.2010"					
A104.	BK23.10-C	"Natural gas water-cooled"		"G-23.10-F1/3-abcd1 01.01.2008"						
A104.-W	BK23.10-C-W-V/-H	"Natural gas water-cooled modular"			"G-23.10-F1/3-abcd1 01.12.2009"	"G-23.10-F1/3-abcd1 01.03.2010"				

8	9	10	11	12	13	14	15	16	17	18
---	---	----	----	----	----	----	----	----	----	----

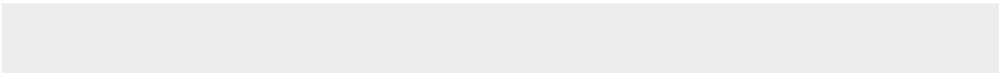
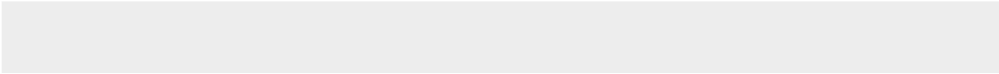
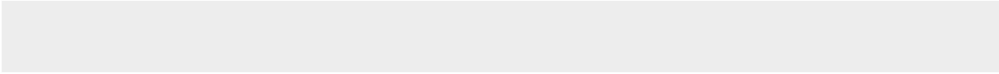
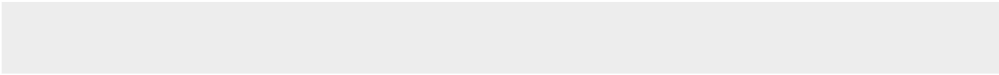
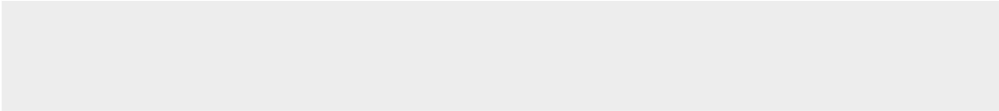
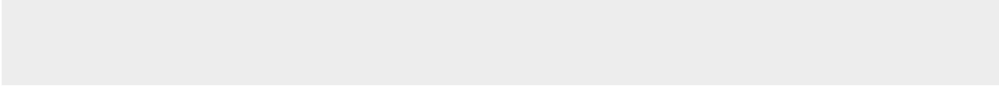

Block / A-list	Block	Sector	Additional inf.	1	2	3	4	5	6	7
A104.	BK23.10-G	"Natural / dry gases water-cooled modular"		"D-23.10-W-F1-abcd1 01.01.2008"						
A104.-W	BK23.10-G-W-V/-H	"Natural / dry gases water-cooled modular"			"D-23.10-W-F2-abcd1 01.12.2009"	"D-23.10-W-F3-abcd1 01.03.2010"				
A104.1-V003	BK23.10-C-F01-V003	"Natural gas air-cooled"		"G-23.10-F1/3-abc1 01.01.2008"						
	BK23.10-GI-F01-V099	"Dry gases air-cooled"		"D-23.10-L-F1-abc1 01.09.2009"						
A104.	BK23.10-GI	"Dry gases water-cooled"		"D-23.10-W-F1-abcd1 01.01.2008"						
A104.-W	BK23.10-GI-W-V/-H	"Dry gases water-cooled modular"			"D-23.10-W-F2-abcd1 01.12.2009"	"D-23.10-W-F3-abcd1 01.03.2010"				
A-104.1-V004	BK23.10-F01-V004	Natural gas		"G-23.10-F1/3-abc1 01.01.2016 Urgent - cylinders of ""d"" kit does not match - order single if required"						
A105.	BK23.12-C	"Natural gas water-cooled"		"G-23.12-W-F1-abc1 01.01.2008"						
A105.-W	BK23.12-C-W-V/-H	"Natural gas water-cooled modular"			"G-23.12-W-F2-abc1 01.02.2009"	"G-23.12-W-F3-abc1 01.03.2010"				
A105.1-V005	BK23.12-F01-V005	Natural gas air-cooled		G-23.12-L-F1-abc1						
A105.	BK23.12-G	Natural / Dry gases water-cooled		"G-23.12-W-F1-abc1 01.01.2008"						
A105.-W	BK23.12-G-W-V/-H	"Natural / dry gases water-cooled modular"			"G-23.12-W-F2-abc1 01.12.2009"	"G-23.12-W-F3-abc1 01.03.2010"				
A105.	"BK23.12-GI See stage block!"	"Dry gases water-cooled"		"D-23.12-W-F1-abc1 01.01.2008"						
A105.2-V004	"BK23.12-F02-V004 Rare F01 possible see breakdown OC"	"Dry gases water-cooled"		"D-23.12-W-F2-abc1 01.01.2015"						
A105.-W	"BK23.12-GI-W-V/-H See stage block!"	"Dry gases water-cooled modular"		"D-23.12-W-F1-abc1 01.01.2008"	" "					

8	9	10	11	12	13	14	15	16	17	18
---	---	----	----	----	----	----	----	----	----	----

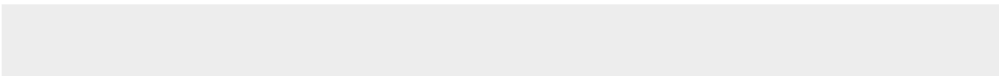
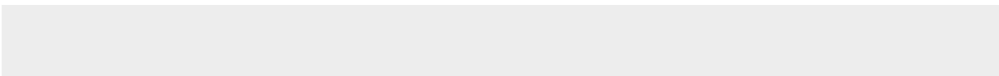
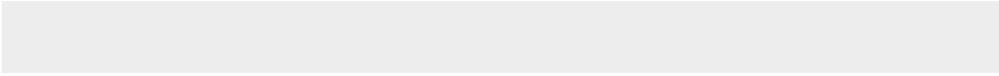
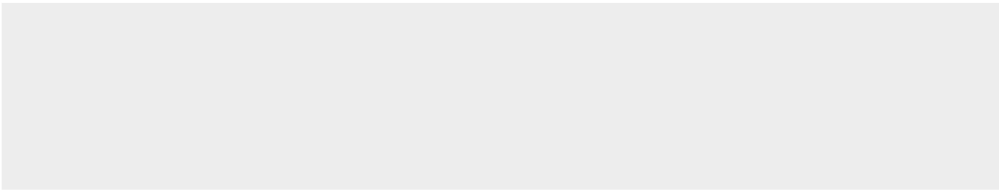
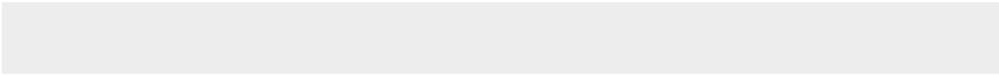
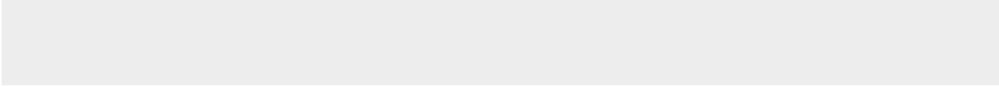

Block / A-list	Block	Sector	Additional inf.	1	2	3	4	5	6	7
A105.-L	BK23.12-GI-L-V/-H	"Dry gases air-cooled modular"	Swagelock	"D-23.12-L-F1-abc1 01.03.2012"						
A105.1-V004	"BK23.12-F01-V004 Kit name is not block name!"	"Dry gases water-cooled"		"D-23.12-W-F3-abc1 01.01.2015"						
A106.	BK23.13-C	"Natural gas water-cooled"		"G-23.13-F1/3-abc1 01.01.2008"						
A106.-W	BK23.13-C-W-V/-H	"Natural gas water-cooled modular"			"G-23.13-F1/3-abc1 01.12.2009"	"G-23.13-F1/3-abc1 01.03.2010"				
A106.	BK23.13-G	Natural / Dry gases water-cooled		"D-23.13-W-F1/3-abc1 01.01.2008"						
A106.-W	BK23.13-G-W-V/-H	"Natural / dry gases water-cooled modular"			"D-23.13-W-F1/3-abc1 01.12.2009"	"D-23.13-W-F1/3-abc1 01.03.2010"				
A106.	BK23.13-GI	"Dry gases water-cooled"		"D-23.13-W-F1/3-abc1 01.01.2008"						
A106.-W	BK23.13-GI-W-V/-H	"Dry gases water-cooled modular"			"D-23.13-W-F1/3-abc1 01.12.2009"	"D-23.13-W-F1/3-abc1 01.03.2010"				
A107.-W	BK23.14-C-W	"Natural gas water-cooled"		"G-23.14-1/2-abc1 01.12.2009"	"G-23.14-F1/2-abc1 01.03.2010"					
A107.	BK23.14-G	Natural / Dry gases		"D-23.14-W-F1/2-abc1 01.12.2009"	"D-23.14-W-F1/2-abc1 01.03.2010"					
A107.	BK23.14-GI	Dry gases		"D-23.14-W-F1/2-abc1 01.12.2009"	"D-23.14-W-F1/2-abc1 01.03.2010"					
A76.	IK24.0-C	"Natural gas water-cooled"		"G-24.0-W-F1/3-abc1 01.05.2006"	"G-24.0-W-F1/3-abc1 01.04.2008"	"G-24.0-W-F1/3-abc1 15.10.2012"				
A123.1s	IK24.0	Industrial air		"I-24.0-W-F1-abc1 01.10.2013"						
A37.	IK24.4	Water-cooled		"I-24.4-W-F1/2-abc1 01.09.2006"	"I-24.4-W-F1/2-abc1 01.04.2008"					
A100.	BK24.11-C	"Natural gas air-cooled / water-cooled"		"G-24.11-F1/2-abc1 01.01.2006"						
A100.	BK24.11-C-W/-L	"Natural gas air-cooled / water-cooled"			"G-24.11-L-F2-abc1 01.04.2008"					
A100.-W	BK24.11-C-W	"Natural gas water-cooled"		"G-24.11-W-F1-abc1 01.01.2006"		"G-24.11-W-F3-abc1 01.03.2010"				

8	9	10	11	12	13	14	15	16	17	18
---	---	----	----	----	----	----	----	----	----	----

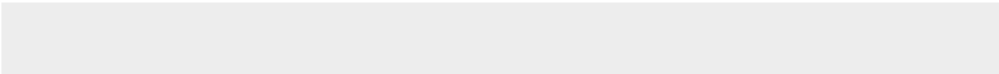
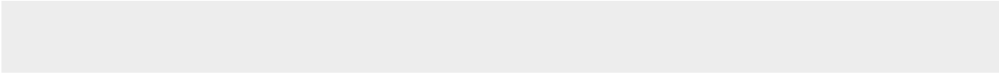
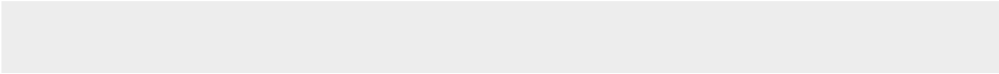
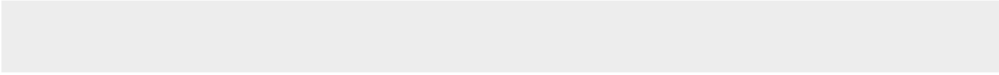
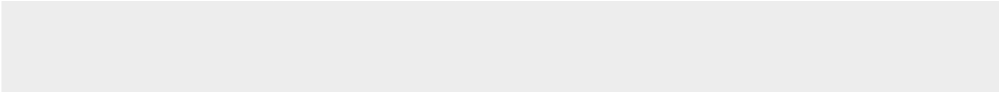
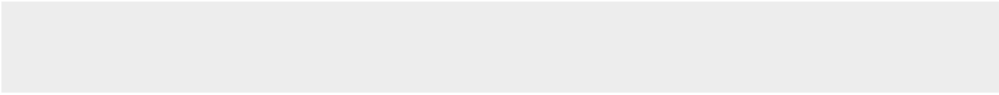

Block / A-list	Block	Sector	Additional inf.	1	2	3	4	5	6	7
A100.-L	BK24.11-C-L	"Natural gas air-cooled"		"G-24.11-L-F1-abc1 01.01.2006"						
A116.	BK24.12-C	"Natural gas water-cooled"	Swagelock				"G-24.12-W-F3-abc1 15.10.2012"			
A121	BK24.12-GI	"Dry gases water-cooled"		"D-24.12-W-F1-abc1 01.01.2013"						
A102.	BK24.19-V001	Bin block		"Kit not yet created 01.08.2007"	"Kit not yet created 01.04.2008"					
A103.	BK24.20-V001	Bin block		"I-24.20.F1/2-abc1 01.08.2007"	"I-24.20.F1/2-abc1 01.04.2008"					
Not specified	BK24.20-C-V001	"Natural gas water-cooled"		"G-24.20-W-F1-abc1 01.01.2013"						
A119	BK24.20-GI	"Dry gases water-cooled"		"D-24.20-W-F1-abc1 01.01.2013"						
A7.	K25.0	Industrial air		"No kit available 01.10.1982"	"I-25.0-F2/4-abc1 21.07.1983"	"I-25.0-F2/4-abc1 20.06.1986"	"I-25.0-F2/4-abc1 03.02.1994"	"I-25.0-F5-abc1 01.01.1996"	"I-25.0-F6-abc1 01.07.2011"	
A46.	IK25.0-G	Natural / Dry gases		"No kit available 01.10.1982"	"I-25.0-F2/4-abc1 21.07.1983"	"I-25.0-F2/4-abc1 01.10.1989"	"I-25.0-F2/4-abc1 03.02.1994"			
A46.	IK25.0-C	Natural gas		"No kit available 01.10.1982"	"I-25.0-F2/4-abc1 21.07.1983"	"I-25.0-F2/4-abc1 01.10.1989"	"I-25.0-F2/4-abc1 01.01.1996"	"G-25.0-F5-abc1 01.01.1996"	"G-25.0-F6-abc1 01.07.2004"	
A46.	IK25.0-GI	Dry gases						"D-25.0-F5-abc1 01.01.1996"		
A23.	IK25.4	Industrial air		"I-25.4-F1/2-abc1 09.07.1984"	"I-25.4-F1/2-abc1 02.02.1994"	"I-25.4-F3-abc1 01.06.2012"				
A65.	IK25.4-GI	Dry gases		"D-25.4-F1/2-abc1 09.07.1984"	"D-25.4-F1/2-abc1 01.02.1994"					
A24.	IK25.5	"No kit (low quantity of blocks)"		"No kit available 14.01.1985"	"No kit available 02.02.1994"					
A66.	IK25.5-GI	"No kit (low quantity of blocks)"		"No kit available 14.01.1985"	"No kit available 01.02.1994"					
A16.	IK25.9	Industrial air		"I-25.9-F1/3-abc1 18.11.1991"	"I-25.9-F1/3-abc1 03.02.1994"	"I-25.9-F1/3-abc1 20.02.2002"				
A49.	IK25.9-G	Natural / Dry gases		"I-25.9-F1/3-abc1 01.10.1991"	"I-25.9-F1/3-abc1 03.02.1994"	"I-25.9-F1/3-abc1 20.02.2002"				
A49.-G	IK25.9-G	Natural / Dry gases water-cooled					"D-25.9-W-F4-abc1 01.01.2006"			

8	9	10	11	12	13	14	15	16	17	18
---	---	----	----	----	----	----	----	----	----	----

[Redacted content]

[Redacted content]

[Redacted content]

[Redacted content]

[Redacted content]

[Redacted content]

[Redacted content]

[Redacted content]

[Redacted content]

Block / A-list	Block	Sector	Additional inf.	1	2	3	4	5	6	7
A49.	IK25.9-C	Natural gas				"G-25.9-L-F3-abc1 21.03.2002"				
A87.	BK25.12	"No kit (low quantity of blocks)"		"No kit available 01.11.1988"						
A88.	BK25.14	"No kit (low quantity of blocks)"		"No kit available 01.02.1989"						
A12.	IK25.18	Industrial air		"I-25.18-F1-abc1 14.07.1986"	"I-25.18-F2/3-abc1 03.02.1994"	"I-25.18-F2/3-abc1 20.03.2002"				
A53.	IK25.18-G	Gas / Dry gases		"I-25.18-F1-abc1 04.07.1986"	"I-25.18-F2/3-abc1 03.02.1994"					
A53.	IK25.18-GI	Dry gases		"I-25.18-F1-abc1 04.07.1986"	"I-25.18-F2/3-abc1 03.02.1994"					
A84.	BK25.19	"No kit (low quantity of blocks)"		"No kit available 01.07.1986"						
A91.	BK25.20	"No kit (low quantity of blocks)"		"No kit available 14.08.1990"						
A80.	IK26.0-C	"Natural gas water-cooled"	Swagelock	"G-26.0-W-F1-abcd1 01.06.2012 - modified 2. Stage !"		"G-26.0-W-F3-abcd1 01.02.2014"				
A118.	IK26.0	"Industrial air water-cooled"	Swagelock	"I-26.0-W-F1-abcd1 01.01.2013"		"I-26.0-W-F3-abcd1 01.02.2014"				
A133.1	BK26.78.0	"Industrial air water-cooled"		I-177585-ab-cde1						
A133.1r	BK26.78.0	"Dry gases water-cooled"		"D-177585-ab-cde1 24.08.2017"						
A133.1r	BK26.78.0	"Natural gas water-cooled"		"G-177585-ab-cde1 24.08.2017"						
A133	BK26.90.0	"Industrial air water-cooled"		I-176370-ab-cde1						
A133.1r	BK26.90.0	"Dry gases water-cooled"		"D-176370-ab-cde1 24.08.2017"						
A133.1r	BK26.90.0	"Natural gas water-cooled"		"G-176370-ab-cde1 24.08.2017"						
A129.1-V004	BK26.2-F01-V004	"Natural gas water-cooled"		"G-26.2-W-F1-abcd1 03.2016"						
A38.	IK26.4-GI	"Dry gases water-cooled"		"D-26.4-W-F1-abcd1 01.08.2011"		"D-26.0-W-F3-abcd1 01.02.2014"				

8	9	10	11	12	13	14	15	16	17	18
---	---	----	----	----	----	----	----	----	----	----

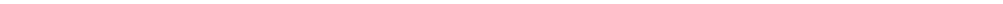
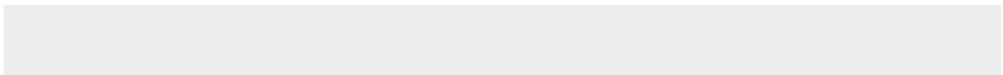
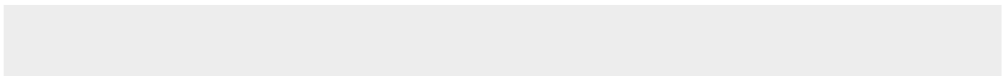
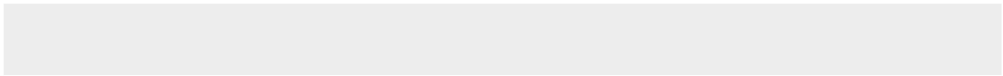
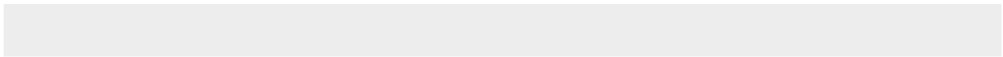
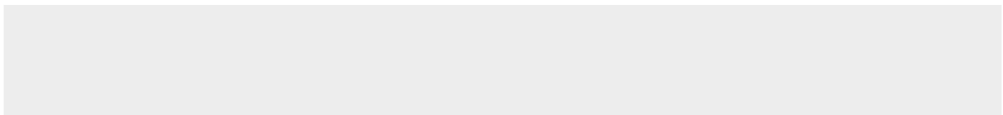
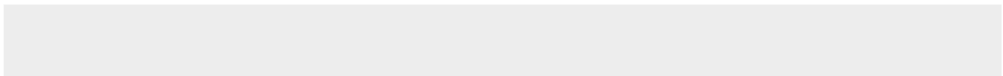
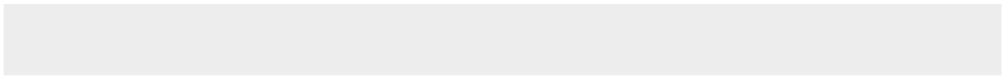
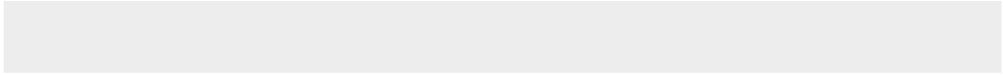
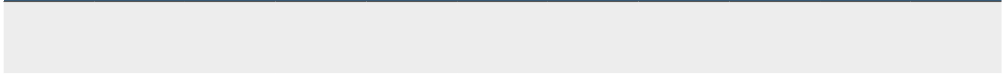

Block / A-list	Block	Sector	Additional inf.	1	2	3	4	5	6	7
A124.1s	IK26.4	"Industrial air water-cooled"	Swagelock	"I-26.4-W-F1-abc1 01.10.2013"						
A79.	IK26.4-C	"Natural gas water-cooled"	Swagelock	"G-26.4-W-F1-abc1 01.08.2011"						
A120	BK26.7-GI	"Dry gases water-cooled"	Swagelock	"D-26.7-W-F1-abc1 01.02.2013"						
A120	BK26.7-C	"Natural gas water-cooled"		"G-26.7-W-F1-abc1 01.02.2013"						
A115.	BK26.8-G/-GI	"Dry gases water-cooled"		"D-26.8-W-F1-abc1 01.06.2012"						
A115.	BK26.8-C	"Natural gas water-cooled"		"G-26.8-W-F1-abc1 01.06.2012"						
A111.	BK26.10-G	"Dry gases water-cooled"		"D-26.10-W-F1-abc1 01.01.2011"						
A108.	BK26.10-C	"Natural gas water-cooled"		"G-26.10-W-F1-abcde1 01.06.2009"	"G-26.10-W-F2-abcde1 01.10.2010"					
A112.	BK26.10-GI	"Dry gases water-cooled"		"D-26.10-W-F1-abc1 01.01.2010"						
A112.-V097	BK26.10-GI	"Dry gases water-cooled"	Swagelock	"D-26.10-W-F1-abc1 01.11.2012"						
A135.1	BK26.78.10	"Dry gases water-cooled"		D-176094-abcde1						
A135.1	BK26.78.10	Natural gas		G-176094-abcde1						
A135.1	BK26.90.10	"Dry gases water-cooled"		D-177593-abcde1						
A135.1	BK26.90.10	Natural gas		G-177593-abcde1						
A113.2-V004	BK26.12-F02-V004	Natural gas		"G-26.12-W-F2-abcde 07.2014"						
A113.	BK26.12-GI	"Dry gases water-cooled"		"I-26.12-F1-abc1 01.07.2011"						
A113.-V097	BK26.12-GI	"Dry gases water-cooled"	Swagelock	"I-26.12-F1-abc1 01.02.2013"						
A113	BK26.12-F03-V004	"Dry gases water-cooled"				"D-26.12-W-F3-abc1 01.07.2014"				
A113.	BK26.12-GI-420-F01-V097	"Dry gases water-cooled"				"D-26.12-W-F3-abc1 01.07.2014"				

8

9

10

11

12

13

14

15

16

17

18

Block / A-list	Block	Sector	Additional inf.	1	2	3	4	5	6	7
A113	BK26.12-F03-V004	Industrial air				"I-26.12-W-F3-abc1 01.09.2014"				
A113	BK26.12-F03-V004	Natural gas				"G-26.12-W-F3-abc1 01.09.2014"				
A136.1	BK26.78.12	"Dry gases water-cooled"		D-177594-abcde1						
A136.1	BK26.78.12	Natural gas		G-177594-abcde1						
A136.1	BK26.90.12	"Dry gases water-cooled"		D-177595-abcde1						
A136.1	BK26.90.12	Natural gas		G-177595-abcde1						
Not specified	BK26.13-C-F01-V097	Natural gas		"G-26.13-W-F1-abc1 09.2014"						
A122	BK26.14-C	"Natural gas water-cooled"	Swagelock	"G-26.14-W-F1-abc1 01.09.2014"						
A8.	K28.0	Industrial air		"No kit available 01.12.1984"	"I-28.0-L-F2/3-abc1 01.01.1996"	"I-28.0-L-F2/3-abc1 01.01.1996"	"I-28.0-L-F4-abc1 01.06.2012"			
A8.-W	K28.0	"Industrial air water-cooled"					"I-28.0-W-F4-abc1 01.08.2008"	"I-28.0-W-F5-abc1 01.06.2012"		
A47.	IK28.0-G	Natural / Dry gases		"No kit available 02.03.1989"	"I-28.0-L-F2/3-abc1 02.02.1994"					
A47.	IK28.0-C	Natural gas		"No kit available 07.03.1989"	"I-28.0-L-F2/3-abc1 02.02.1994"	"G-28.0-F3-abc1 01.01.1996"				
A47.-C	IK28.0-C	"Natural gas water-cooled"				"G-28.0-F3-abc1 01.01.1996"	"G-28.0-W-F4-abc1 01.04.2008"	"G-28.0-W-F5-abc1 01.06.2012"		
A47.-GI	IK28.0 GI	Dry gases			"D-28.0-L-F2/3-abc1 02.02.1994"	"D-28.0-L-F2/3-abc1 01.07.2002"	"D-28.0-L-F4-abc1 01.06.2012"			
A47.-GI	IK28.0 GI	"Dry gases water-cooled"					"D-28.0-W-F4-abc1 01.06.2012"			
A27.	IK28.2	Industrial air		"I-28.2-F1-abc1 09.07.1984"	"I-28.2-F2-abc1 02.02.1994"	"I-28.2-F3-abc1 01.06.2012"				
A27.-W	IK28.2	"Industrial air water-cooled"				"I-28.2-W-F3-abc1 01.02.2009"	"I-28.2-W-F4-abc1 01.06.2012"			
A67.	IK28.2-GI	Dry gases		"D-28.2-F1-abc1 09.07.1984"	"D-28.2-F2-abc1 01.02.1994"					
A28.	IK28.3	Industrial air		"No kit available 14.01.1985"	"I-28.3-F2-abc1 02.02.1994"					

8	9	10	11	12	13	14	15	16	17	18
---	---	----	----	----	----	----	----	----	----	----

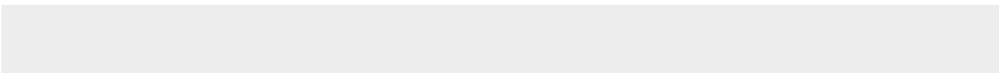
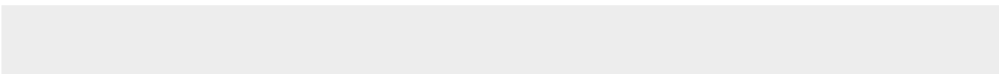
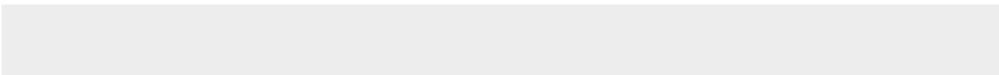
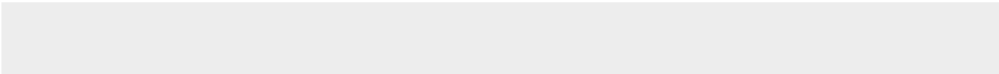
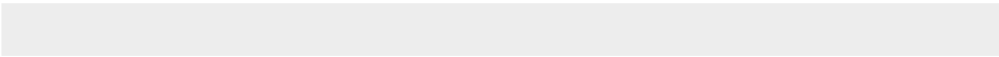
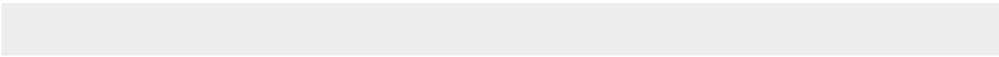

Block / A-list	Block	Sector	Additional inf.	1	2	3	4	5	6	7
A68.	IK28.3-G	"No kit (low quantity of blocks)"		"No kit available 01.08.1990"						
A68.	IK28.3-GI	Dry gases			"I-28.3- F2-abc1 02.02.1994"					
A94.	BK28.21-C	Natural gas		"G-28.21- F1-abcd1 01.01.1996"						
A94.	BK28.21-C	"Natural gas water-cooled"						"G-28.21- W-F4-abc1 01.08.2008"		
A94.	BK28.22-C	Natural gas		"G-28.22- F1-abcd1 01.01.1996"						
A94.	BK28.22-C	"Natural gas water-cooled"				"G-28.22- W-F3-abc1 01.08.2008"				
A94.	BK28.23-C	Natural gas		"G-28.23- F1-abcd1 01.01.1996"						
A94.	BK28.23-C	"Natural gas water-cooled"				"G-28.23- W-F3-abc1 01.08.2008"				
A94.	BK28.24-C	Natural gas		"G-28.24- F1/2-abc1 01.01.1996"						
A94.	BK28.24-C	"Natural gas water-cooled"				"G-28.24- F3-abc1 01.08.2008"				
A30.	D51.1	Oil free		"No kit available 22.01.1992"	"No kit available 03.11.1993"					
A30.	D51.2	Oil free		"No kit available 22.01.1992"	"No kit available 03.11.1993"					
A31.	D52.3	Oil free		"No kit available 22.01.1992"	"No kit available 03.11.1993"					
A130	BK52.10	"Natural gas water-cooled"		"G-52.10- W-F1-abc1 01.01.2017"						
A126.1	BK52.12	"Natural gas water-cooled"		"G-52.12- W-F1-abc1 2014"						
A-126.2-V004	BK52.12	Dry gases			"D-52.12- W-F2-abc1 14.12.2017"					
A127.1	BK52.13	"Natural gas water-cooled"		"G-52.13- W-F1-abc1 2014"						
A31.	D52.4	Oil free		"No kit available 22.01.1992"	"No kit available 03.11.1993"					

8	9	10	11	12	13	14	15	16	17	18
---	---	----	----	----	----	----	----	----	----	----

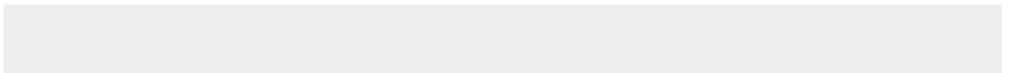
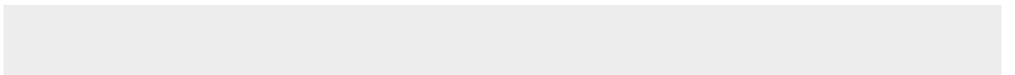
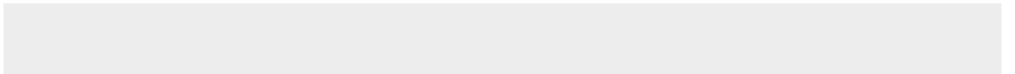
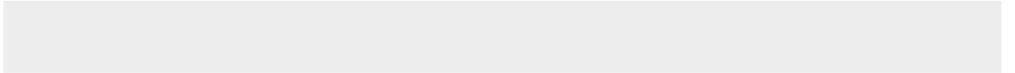
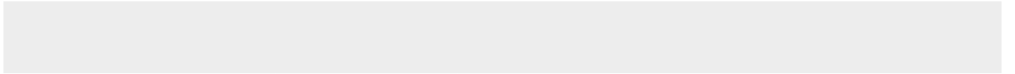
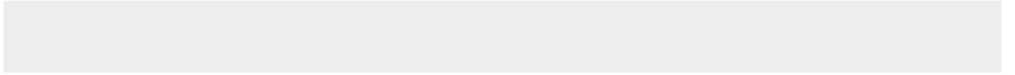
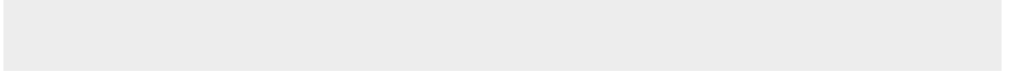
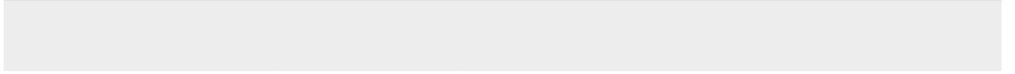

Block / A-list	Block	Sector	Additional inf.	1	2	3	4	5	6	7
A34.	IK930	Alup low pressure		"Alup - No kit available 17.12.1990"						
A35.	IK940	Alup low pressure		"Alup - No kit available 17.12.1990"						
A36.	D81.2	"No kit (low quantity of blocks)"		"No kit available 20.02.1992"	"No kit available 20.08.1996"					
A69.	SF6-20	"No kit (low quantity of blocks)"		"No kit available 01.05.1993"						
A70.	D53.5-GI	Dry gases		"I-53.5-F1-abc1 01.01.1995"	"I-53.5-F2-abc1 01.09.1999"					
A82.	BK89	"No kit (low quantity of blocks)"		"No kit available 01.12.1985"						
A83.	BK89.2	"No kit (low quantity of blocks)"		"No kit available 01.12.1985"						
A95.	BDGI52.7-3	"No kit (low quantity of blocks)"		"No kit available 01.08.1996"						
Not specified	EVO15 - Screw 26.12-SP	Industrial air		"I-EVO15-F1-a1 13.10.2014"						
Not specified	EVO15 - Screw 26.12-SP	Dry gases		"D-EVO15-F1-a1 15.07.2019"						
Not specified	EVO28 - Screw	Industrial air		"I-EVO28-F1-a1 05.2019"						

8	9	10	11	12	13	14	15	16	17	18
---	---	----	----	----	----	----	----	----	----	----

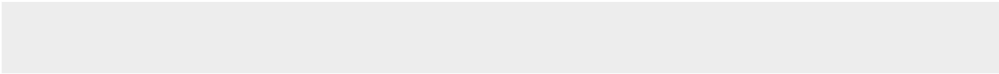
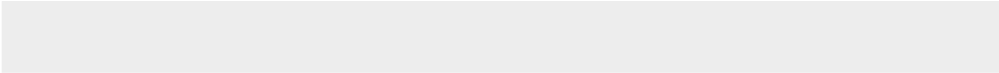
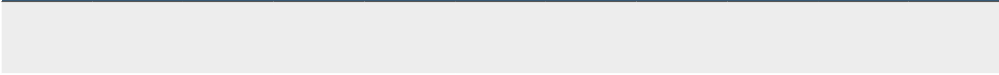

"No kit available
05.05.1989"

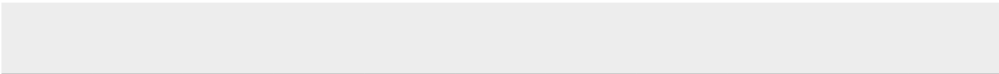
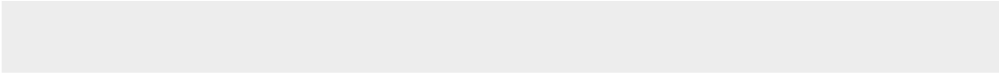

BAUER PROMO MATERIALS

FLY THE FLAG WITH STYLE AND QUALITY



CLOTHING



On pre-order only, delivery time: 4 weeks

BAUER BUSINESS SHIRT

Exceptionally high-quality shirt from the well-known manufacturer, Eterna, featuring a durable and crease-proof finish.

Colour:	White
Design:	Long-sleeved, Kent-style collar, choice slimline or relaxed fit
Material:	100 percent cotton/non-iron
Branding:	Embroidered block logo on the right-hand collar
Sizes:	38,39,40,41,42,43,44,45,46 (European sizes)
MOQ:	5 pieces
Order no.:	Size 38* N32249, size 39* N32250, size 40* N32251, size 41* N32252, size 42* N32253, size 43* N32254, size 44* N32255, size 45* N32256, size 46* N32257



On pre-order only, delivery time: 4 weeks

BAUER POLO SHIRT

High quality polo shirt in heavyweight quality made from 100 percent brushed cotton with easy-wearing comfort.

Colour:	navy blue
Design:	Short-sleeved, 3-button strip, longer back panel
Material:	Cotton piqué, 220 g/m ²
Branding:	Embroidered BAUER logo on the side of the chest
Sizes:	S,M,L,XL;XXL
MOQ:	5 pieces
Order no.:	Size S* N31388, size M* N31988, size L* N31989, size XL* N31990, size XXL* N31991



On pre-order only
Delivery time: 4 weeks

BAUER SOFTSHELL GILET OR JACKET

Comfortable, windproof softshell outer layer wear with a sporty cut and microfleece inner lining. Available as either a jacket or gilet.

- Colour:** navy blue
Design: Sleeveless, full length zip fastener with windproof panel, 2 zipped pockets
Material: 93% polyester / 7% elastane
Branding: Embroidered BAUER logo.
Sizes: S, M, L, XL; XXL
MOQ: 5 pieces
Order no.: **Gilet:**
 Size S* N43864, size M* N43865
 size L * N43866, size XL * N43867
 size XXL * N43868
Jacket:
 Size S* N43859, size M* N43860
 size L * N43861, size XL * N43862
 size XXL * N43863



Softshell gilet

Softshell jacket

BASEBALL CAP AND BAGS

BAUER BASEBALL CAP

Comfy 6-panel cap made from heavyweight cotton with pre-formed visor and brass clip for size adjustment

Colour:	Navy blue
Material:	Heavyweight, brushed cotton
Branding:	Embroidered block logo pattern on the front visor
Sizes:	One size
MOQ:*	10 pieces
Order no.:	N31384



BAUER MESSENGER BAG

Ultra-robust and trendy messenger bag, providing space for a wide folder and that protects against poor weather conditions with ease thanks to its tarpaulin material.

Colour:	Cyan
Material:	HGV tarpaulin material
Design:	With edge trims, compartments for pens and mobile phone, as well as inner compartments
Branding:	Engraved block logo as well as BAUER combined logo on the fold-over cover
Size:	W 37 x H 29 x D 13 cm
MOQ:*	5 pieces
Order no.:	N34404



BAUER BIG BAG

The large shoulder bag made from robust non-woven material can be carried on the shoulder thanks to the long carry handles, and offers plenty of space. Makes a real impact from afar with its striking print design.

Colour:	Royal blue
Material:	Polyester nonwoven, 80 g/m ²
Branding:	Engraved block logo as well as BAUER logo
Size:	W 50 x H 40 x D 15 cm
Availability:	From stock
MOQ:*	25 pieces
Order no.:	N43858

GIVEAWAYS



BAUER BLOCK PIN

Elegant metal pin with 3D design, polished edges and enamelled logo areas that will gain many fans at any event.

Colour:	Silver/blue
Material:	Metal, nickel-plated, pin fastening
Branding:	BAUER block logo combination
Size:	25 mm (diameter)
MOQ:*	25 pieces
Order no.:	N31397

BAUER LANYARD

A classic in the BAUER range, which stands out from the usual mass-produced goods thanks to its high-quality workmanship with woven, sewn-on logo band, quick-release fastener and extra large, robust carabiner.



Colour:	Cyan/navy, with white woven logos
Material:	Polyester
Branding:	BAUER logo, block logo and slogan: Pure Air Safe Diving
Size:	W 25 x L 620 mm
MOQ:*	25 pieces
Order no.:	N31390



BAUER TUBE SCARF

Protects against wind and weather, can be worn in various ways, as a neck scarf or head scarf in a stylish navy camouflage design.

Colour:	Blue or orange camouflage pattern
Material:	Skin-friendly stretch material made from polyester
Branding:	BAUER logo and block logo as watermark
Size:	W 250 x L 390 mm
MOQ:*	10 pieces
Order no.:	blue: N40386 orange: N43857



OFFICE AND ORGANISATION

BAUER USB STICK

Fast, folding USB 3.0 Stick with 8 GB capacity. Supplied in a carton with printed logo.

Colour:	Black/silver
Material:	Plastic/metal
Branding:	BAUER logo on stick
Size:	W 55 x L 18 mm (folded)
MOQ:*	10 pieces
Order no.:	N36305



BAUER PROMO CLIP

High-quality, high-impact clip with printed design for clipping documents together.

Colour:	Blue/white on silver
Material:	Stainless spring steel
Branding:	BAUER block logo and web address
Size:	W 14 x L 29 mm
MOQ:*	25 pieces
Order no.:	N43856



BAUER STICKY NOTES SET

Practical set of sticky notes with hard cover in two sizes and write-on transparent plastic bookmarks in 5 colours.

Colour:	Blue/silver (cover)
Material:	Cardboard/paper
Branding:	BAUER GROUP logo and block logo
Size:	W 105 x L 78 mm
MOQ:*	10 pieces
Order no.:	N43855





BAUER BALLPOINT PEN

Trusty ballpoint pen with large blue cartridge and wide clip.

Colour:	Royal blue
Material:	Transparent plastic
Branding:	BAUER logo and web address
Size:	W 12 x L 145 mm
MOQ:*	25 pieces
Order no.:	N31396



BAUER LUXURY WRITING SET

Dual set comprising rollerball pen and pencil in an attractive gift box.

Colour:	Black with chrome highlights
Material:	Metal
Branding:	BAUER GROUP
Size:	W 65 x L 175 mm
MOQ:*	5 pieces
Order no.:	N43854



TOOLS AND TECHNOLOGY

BAUER MULTITOOL

High-quality multitool from the range by the quality manufacturer, Richartz/Solingen, with handles made from satin-polished stainless steel in a black Cordura belt bag.

Colour:	Silver/black
Material:	Leather/metal
Details:	Pliers, knife, saw, file, screwdriver, bottle opener and more
Branding:	BAUER logo and web address
Size:	W 44 x L 103 mm
MOQ:*	5 pieces
Order no.:	N35536



BAUER MINIBIT TOOL

Practical Minibit-Tool with high-grip rubber and ratchet action on both sides.

Protective cap and bit reservoir, which extends automatically at the push of a button.

Colour:	Silver/black
Material:	Plastic/metal
Details:	10 bits (Phillips, slotted, Torx)
Branding:	BAUER logo and web address
Size:	W 30 x L 160 mm
Order no.:	N31399



Only by quotation, and on request
Minimum order quantity 50 pieces



BAUER MULTI-FUNCTIONAL TORCH

Multi-functional torch with LED lamp head and lateral COB work lamp as well as a strong magnet on the back for attachment to metal surfaces and with additional attachment clip.

Colour:	Silver
Material:	Aluminium
Branding:	BAUER logo and web address
Size:	W 20 x L 170 mm
MOQ:*	5 pieces
Order no.:	N31393



BAUER LIGHTER

Gas-powered, refillable storm lighter that defies even strong winds.

Colour:	Silver/black
Material:	Plastic/metal
Branding:	BAUER logo and web address
Size:	W 40 x L 65 mm
Order no.:	N43853

CUPS, MUGS & CO

BAUER BOX OF PEPPERMINTS

Peppermint sweets in a practical metal box

Colour:	cyan blue
Material:	Metal box / peppermint flavoured sweets
Branding:	BAUER GROUP logo / BAUER logo
Size:	W 50 x L 60 mm
MOQ:*	10 pieces
Order no.:	N43852



BAUER GLASS COASTER

Stylish glass coaster made from glass with a satin effect finish and with anti-slip silicone feet that looks great on any table

Colour:	matt white
Material:	glass
Branding:	BAUER GROUP logo, block logo, screw logo
Size:	W 100 x L 100 mm
MOQ:*	5 pieces
Order no.:	N43851



BAUER EVENT CUP

With its frosted finish and a capacity of 300 ml, it is the classic cup for serving drinks at trade shows and events.

Colour:	transparent matt
Material:	Polypropylene
Branding:	Block logo
Size:	W 70 x L 115 mm / 0.3 l
MOQ:*	25
Order no.:	N43850





BAUER THERMAL CUP

Whether hot or cold: The drink you put into the cup stays at the same temperature for hours in this vacuum cup. Easy one-hand operation via the central button and leak-proof, of course.

Colour:	silver/black
Material:	Stainless steel/plastic
Branding:	BAUER logo
Size:	W 75 x L 195 mm / 0.4 l
MOQ:*	5 pieces
Order no.:	N31395

FLAGS AND POSTERS

BAUER DECORATIVE FLAG

Wooden rods on the top and bottom ensure that the textile flag with BAUER logo keeps its shape. Ideal for promotions in a shop or diving base.

Colour:	White/cyan
Material:	Polyester fabric, printed using digital printing techniques.
Branding:	BAUER logo with slogan.
Size:	W 1000 x H 550 mm
MOQ:*	5 pieces
Order no.:	N43849



BAUER ACTION WING FLAG

At a height of 2500 mm height, ideal for good visibility at events. Visible as a mirror image thanks to through-printing. The cross-plate base (5 kg) keeps the ActionWing securely on the ground. Alternatively, the Wing Flag with floor dowel is available for anchoring in loose substrate (sand/snow).

Colour:	White/cyan
Material:	Polyester fabric, printed using digital printing techniques.
Branding:	BAUER logo, block logo, Web address
Size:	W 950 x H 2100 mm (height above floor 2500 mm)
MOQ:*	3 pieces
Order no.:	With cross-plate base N43848 With ground spike N43847

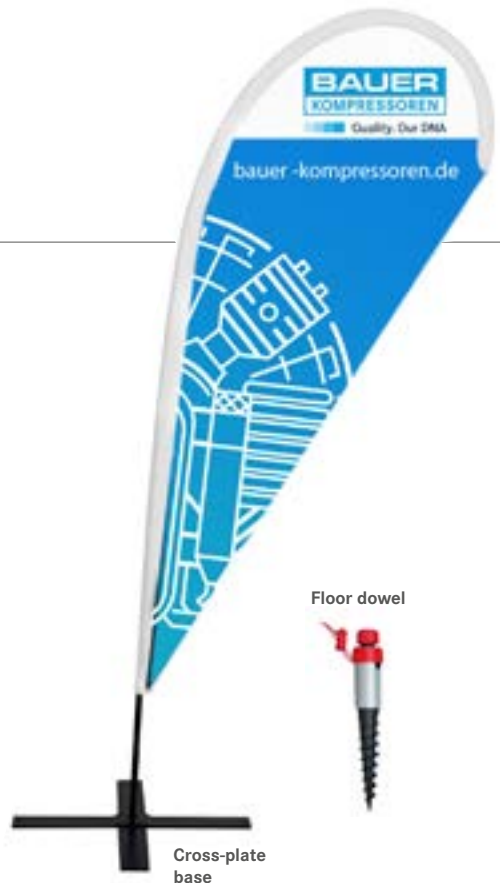

On pre-order only, delivery time: 4 weeks

*Minimum Order Quantity

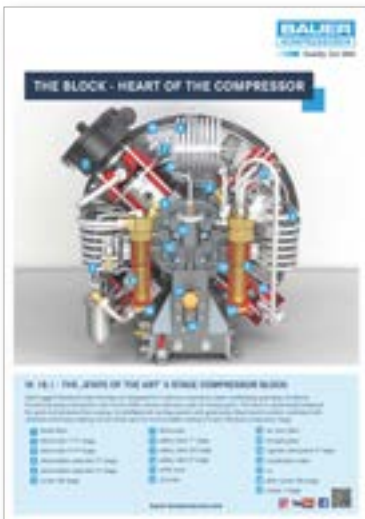

BAUER POSTER IK 18.1 SECTIONAL MODEL

Clear illustration of an IK 18.1 compressor block in its operating mode. Ideal for training or decoration, for example in a shop, diving base or fire station

- Material:** Paper 300 g/m³, double-wrapped in cellophane for protection
- Branding:** BAUER logo
- Size:** W 594 x H 841 mm (DIN A1)
- MOQ:*** 10 pieces
- Order no.:** German N43846
English N43845



**ARE YOU INTERESTED IN ONE OF
OUR PRODUCTS?**

**PLEASE GET IN TOUCH –
WE WILL BE HAPPY TO ASSIST YOU.**

BAUER KOMPRESSOREN GmbH

Stäblistr. 8

D-81477 Munich, Germany

Tel. +49 (0) 89 78049-0

Fax +49 (0) 89 78049-167

info@bauer-kompressoren.de

www.bauer-kompressoren.de



High-pressure accessories catalogue EN

N35160

03.2020

Subject to technical changes